



**H O M E E L E G A N C E**

## Assembly Instruction Accent Chair









ITEM NO.: 1029RN/BE/GY-1

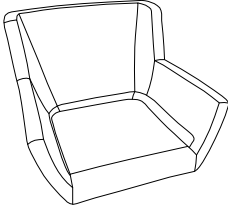

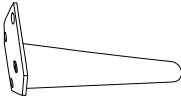
**Legs & hardware are stored in the bottom of the seat, please take them out for assembly.**

**Note: Do not use power tools for assembly. Power tools increase the risk of over tightening which lead to splitting or cracking the wood. Do not tighten bolts until completely assembled.**

### Component list

| No | Drawing   | Qty | Description                           |
|----|---|-----|---------------------------------------|
| A  |   | 1   | Chair                                 |
| B  |  | 1   | Seat cushion                          |
| C  |  | 1   | Back cushion                          |
| D  |  | 2   | Front Wooden Leg<br>8.15"*3.23"*3.23" |
| E  |  | 2   | Rear Wooden Leg<br>7.2"*3.23"*3.23"   |
| F  |  | 12  | Bolts<br>5/16"*32mm                   |
| G  |  | 12  | Flat Washers<br>Ø19*Ø8*1.5mm          |
| H  |  | 12  | Lock Washers<br>5/16"*13*1.5mm        |
| I  |  | 1   | Allen Wrench<br>M4*70*35mm            |

# Step #1

LEGS AND HARDWARE ARE STORED IN THE BOTTOM OF THE SEAT.

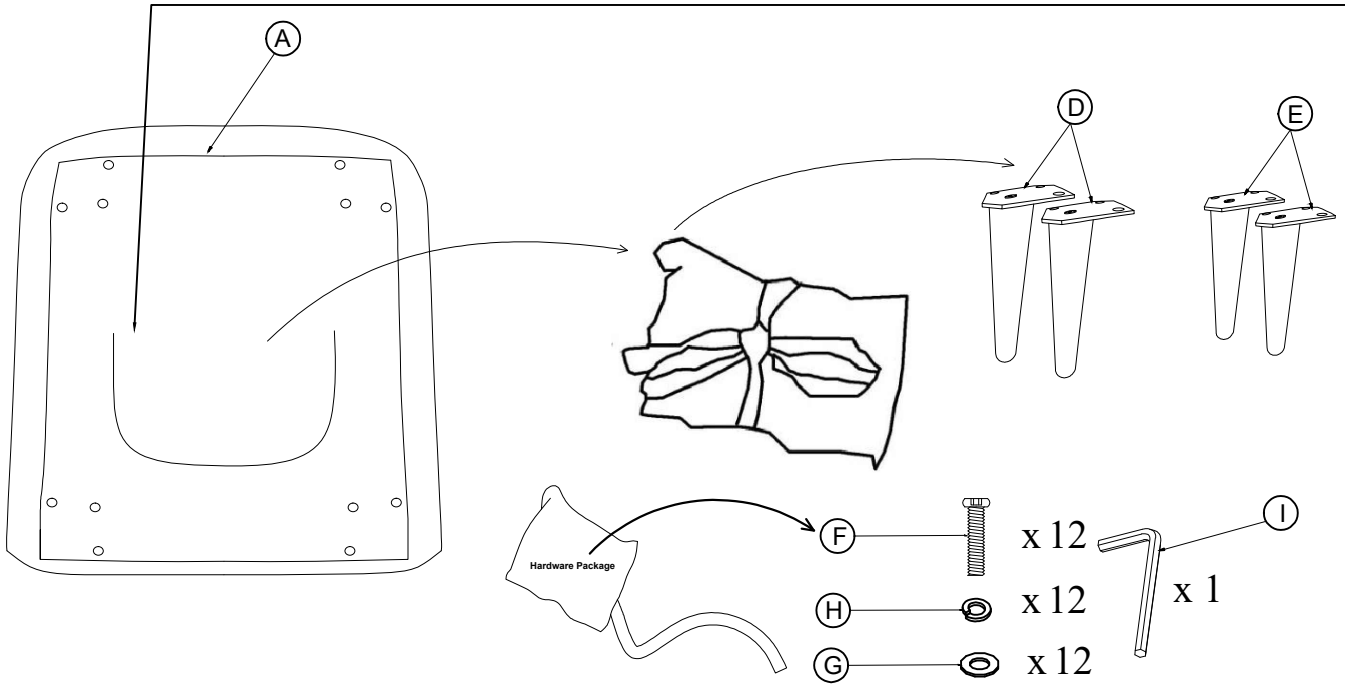

# Step #2

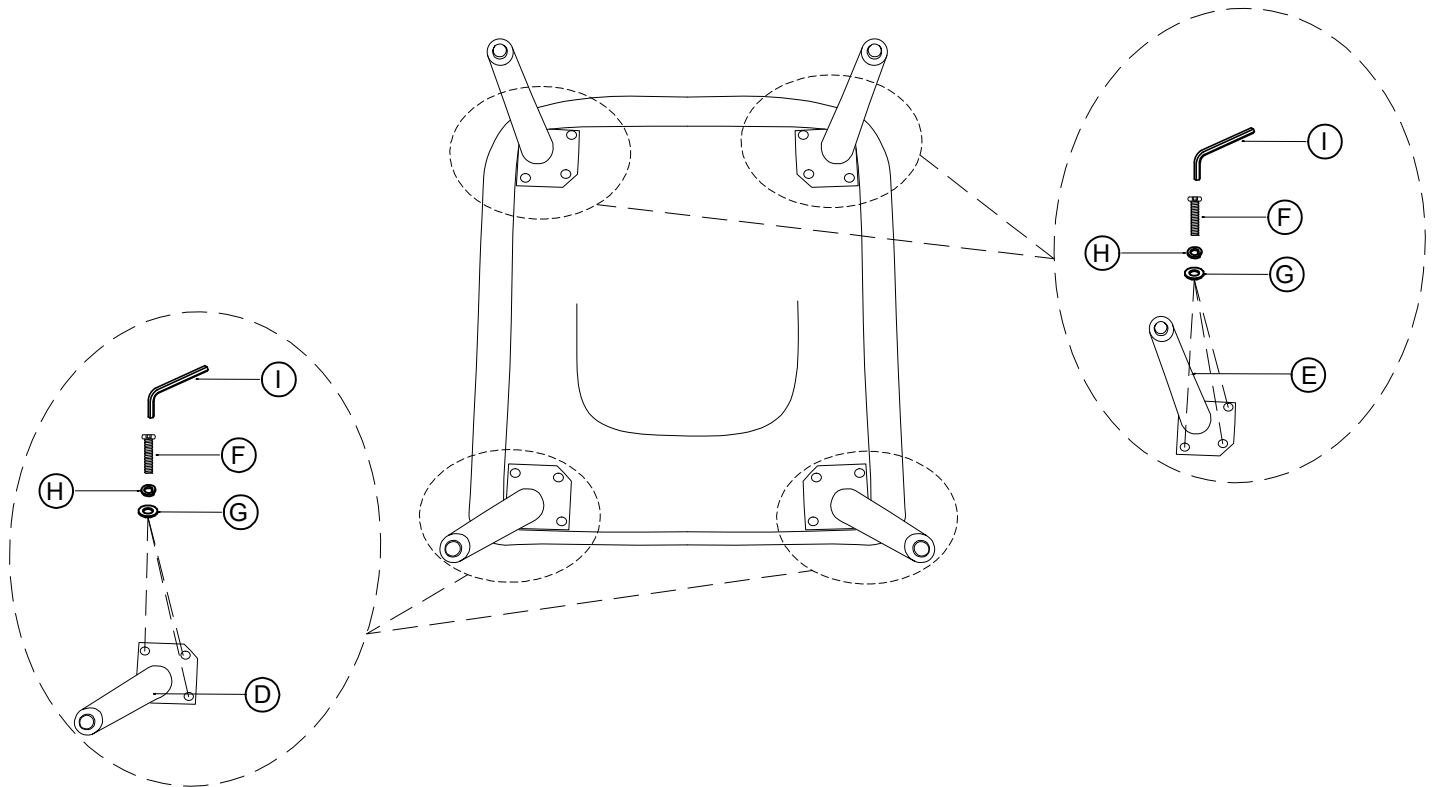

### Step #3

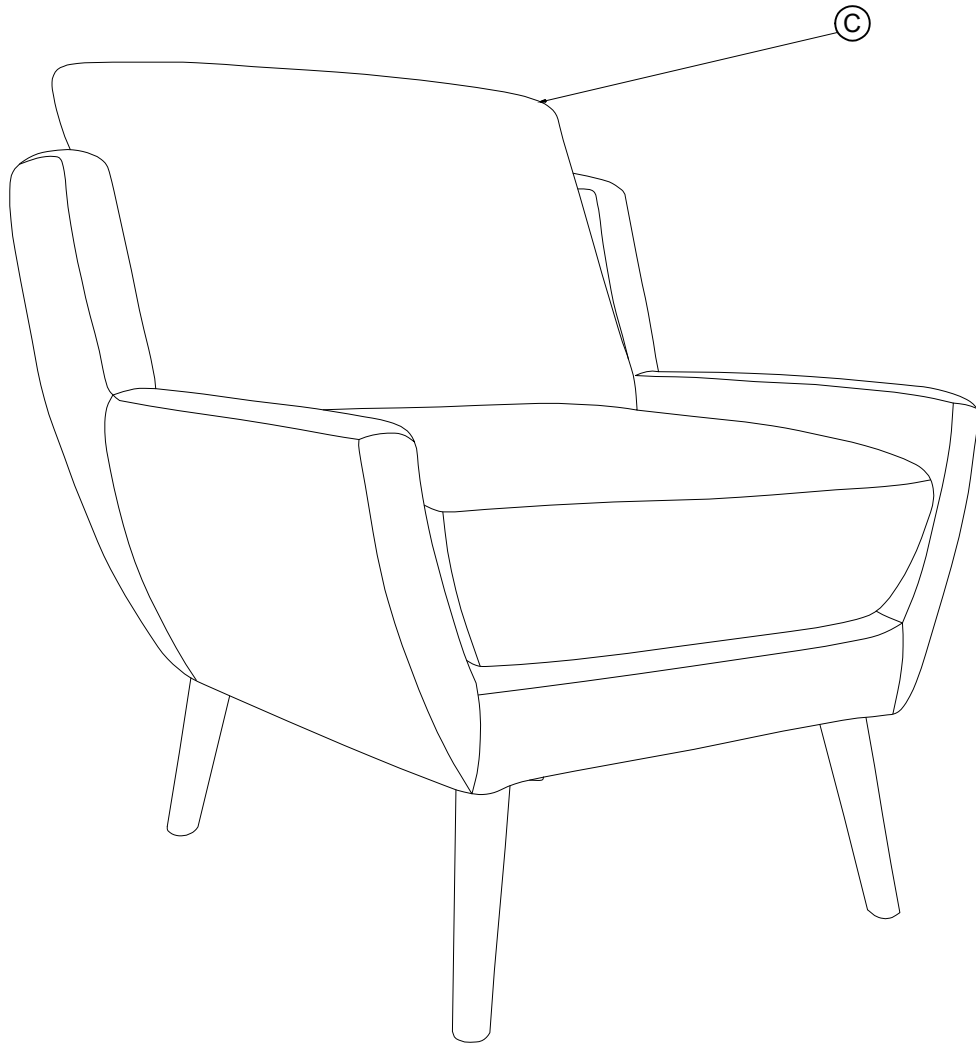

## Care Instruction for Chenille Furniture:

In order to maintain the original appearance of your chenille Furniture, please follow below simple care procedures:

- Avoid exposing furniture directly to sunlight or heating and air conditioning outlets. Sunlight and or exposure to heating and air conditioning outlets will fade/damage chenille.
- Vacuum or wipe with a soft cloth to remove dust.
- Hardware may loosen over time. Periodically check to make sure all connection are tight, Re-tighten if necessary



For items use on wooden floor, hard surfaces or carpets, it is recommended to Install protective pads under all legs and supports to avoid/prevent from damages/scratches and discoloration.