





**ASSEMBLY INSTRUCTIONS INSTRUCTIONS D'ASSEMBLAGE**  
**2423-24 / 2423GY-24 / 2423BR-24**  
**COUNTER HEIGHT CHAIR / CHAISE HAUTEUR COMPTOIR**

Thank you for purchasing this product. Please take time to read and follow the instructions below. Check that you have all parts and hardware before assembly. Parts apparently missing are often found in the packing materials. If you do not have all the parts listed, have your dealer contact us and they will be sent to you immediately.

Merci d'avoir acheté ce produit. Veuillez lire et suivre les instructions ci-dessous. Vérifiez avant le montage que vous avez toutes les pièces et fixations. Les pièces qui semblent manquer se trouvent souvent dans les matériaux d'emballage. Si vous n'avez pas toutes les pièces de la liste, demandez à votre détaillant et nous vous les enverrons immédiatement.







 It is recommended to install protective pads under all legs and supports to avoid damage or scratches when placing furniture on a wood floor or other hard surface, and to limit indentation and prevent discoloration if placing on carpet.

 Il est recommandé de placer des coussins protecteurs sous tous les pieds et toutes les bases des pour éviter d'endommager ou d'égratigner les planchers en bois ou autres surfaces dures, et pour limiter l'empreinte et empêcher la décoloration quand les meubles reposent sur la moquette.







 Hardware may loosen over time. Periodically check to make sure all connections are tight. Re-tighten if necessary.

 Le matériel peut se desserrer au fil du temps. Vérifiez périodiquement que toutes les connexions sont serrées. Serrer à nouveau si nécessaire.

**PARTS LIST**  
**LISTE DE PIÈCES**

No	Sketch / Esquisser	Description / La Description	Q.ty / Q.té
A		Chair Back / Dossier de chaise	1PC
B		Cushion seat / Siège coussiné	1PC
C		LSF Front Leg / Pied avant gauche	1PC
D		RSF Front Leg / Pied avant droite	1PC
E		LSF Side Stretcher / Brancard gauche	1PC
F		RSF Side Stretcher / Brancard droite	1PC
G		Front Stretcher / Brancard avant	1PC

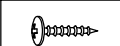
**HARDWARE LIST**  
**LISTE DE QUINCAILLERIE**

No	Description / La Description	Size / Taille	Sketch / Esquisser	Q.ty / Q.té
1	Bolt (Long) / Boulon	Ø1/4"-20 x 3"		4PCS
2	Bolt (medium) / Boulon	Ø1/4"-20 x 2-3/8"		4PCS
3	Bolt (short) / Boulon	Ø1/4"-20 x 1-1/2"		1PCS
4	Spring Washer / Rondelle élastique	Ø1/4" x 9-32" x 13/32"		9PCS
5	Flat Washer / Rondelle Plate	Ø1/4" x 9-32" x 3/4"		9PCS
6	Screws / Vis	#4 x 1-1/2"		6PCS
7	Allen Key / Cle Allen	5/32" x 2-1/4" x 15/16"		1PC

\*\* ABOVE HARDWARE ARE PACKED IN 2423-24 / 2423GY-24 / 2423BR-24 FOR ASSEMBLY.

\*\* LE MATÉRIEL CI-DESSUS EST EMBALLÉ DANS 2423-24 / 2423GY-24 / 2423BR-24 POUR L'ASSEMBLAGE.

\*\* SCREW DRIVER (NOT PROVIDED)

\*\* TOURNEVIS (NON FOURNI)



**STEP 1 / ÉTAPE 1**

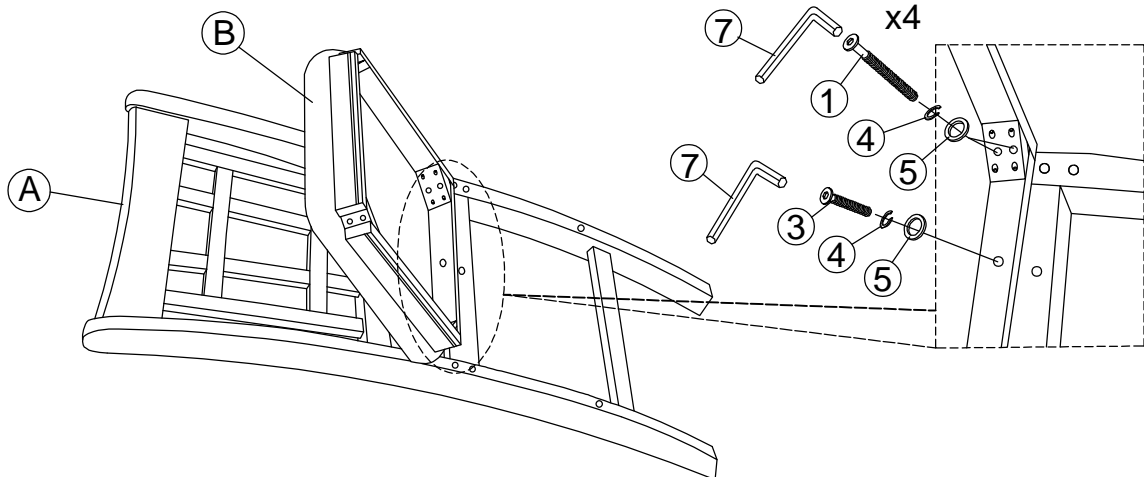



ASSEMBLY INSTRUCTIONS INSTRUCTIONS D'ASSEMBLAGE  
2423-24 / 2423GY-24 / 2423BR-24  
COUNTER HEIGHT CHAIR / CHAISE HAUTEUR COMPTOIR

STEP 2 / ÉTAPE 2

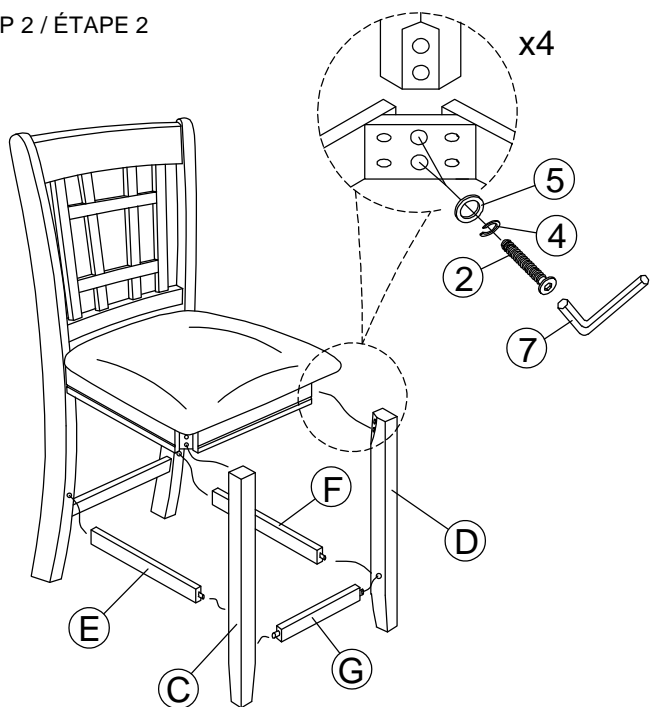

STEP 3 / ÉTAPE 3

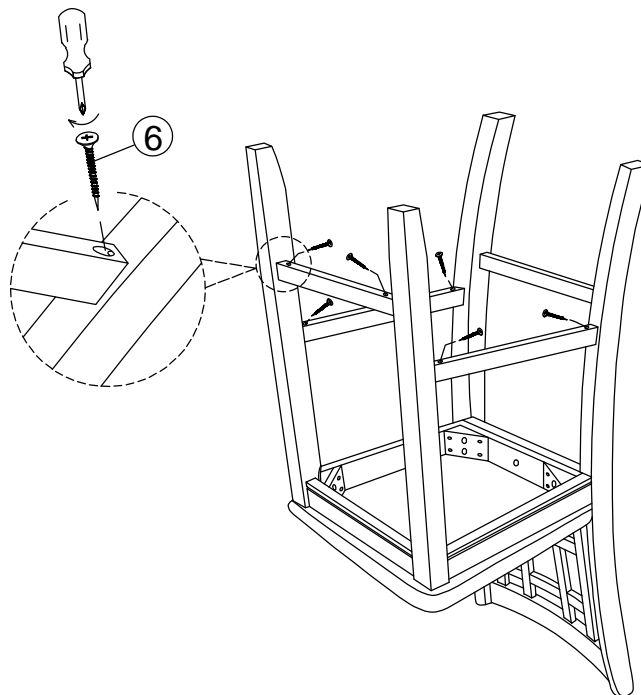

ASSEMBLY COMPLETED  
ASSEMBLAGE COMPLÉTÉ

