

# Assembly Instruction

CHAIR









ITEM NO.: 9733DGY/9733TAN-1

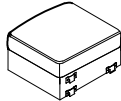
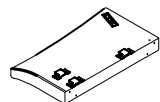
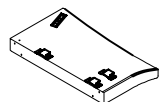

Legs & hardware are packed in the box and stored inside of the carton, please take out for assembly.

Note: Do not use power tools for assembly. Power tools increase the risk of over tightening which lead to splitting or cracking the wood.

## Component list

No	Drawing	Qty	Description
<b>A</b>		<b>1</b>	<b>Chair Seat</b>
<b>B</b>		<b>1</b>	<b>LSF Armrest</b>
<b>C</b>		<b>1</b>	<b>RSF Armrest</b>
<b>D</b>		<b>1</b>	<b>Backrest</b>
<b>E</b>		<b>4</b>	<b>Metal Legs (130*85*85mm)</b>
<b>F</b>		<b>1</b>	<b>Crossbar</b>
<b>G</b>		<b>8</b>	<b>Bolt (5/16"*22mm)</b>
<b>H</b>		<b>8</b>	<b>Flat washer 5/16"*Ø19*1.5mm</b>
<b>I</b>		<b>2</b>	<b>Bolt (1/4"*35mm)</b>
<b>J</b>		<b>2</b>	<b>Flat washer 1/4"*Ø16*1.5mm</b>
<b>K</b>		<b>1</b>	<b>Allen key (M4*59mm)</b>

THE PARTS ARE LOCATED INSIDE THE BOX AS BELOW:

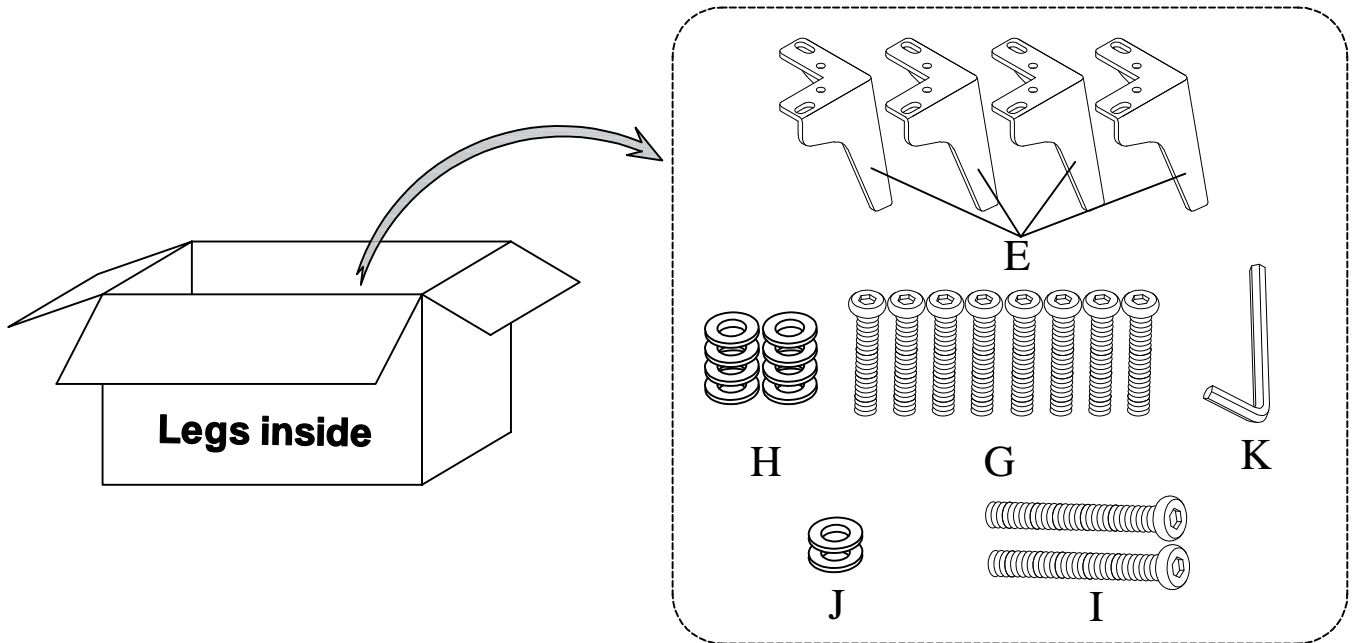
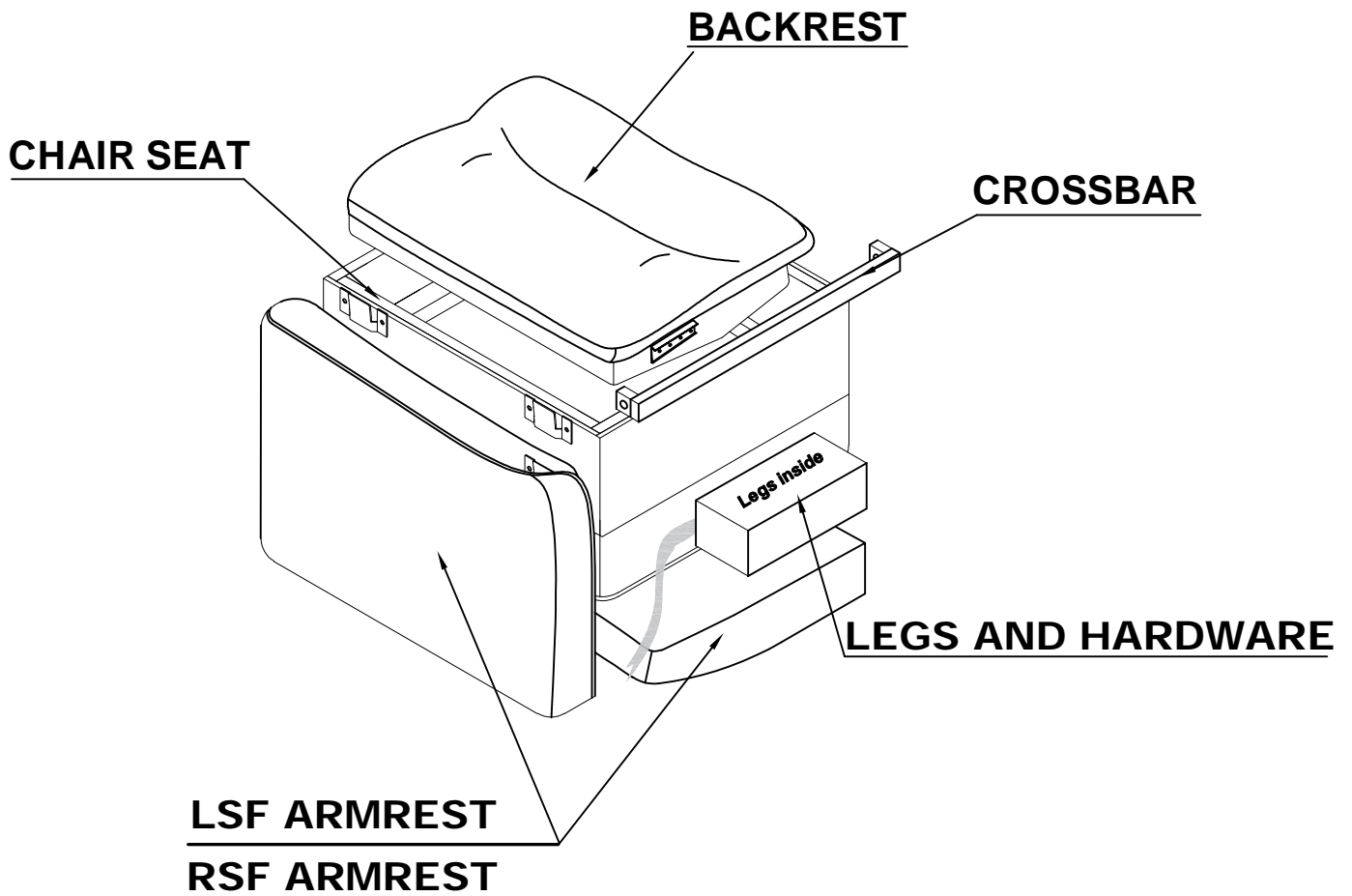

Step #1

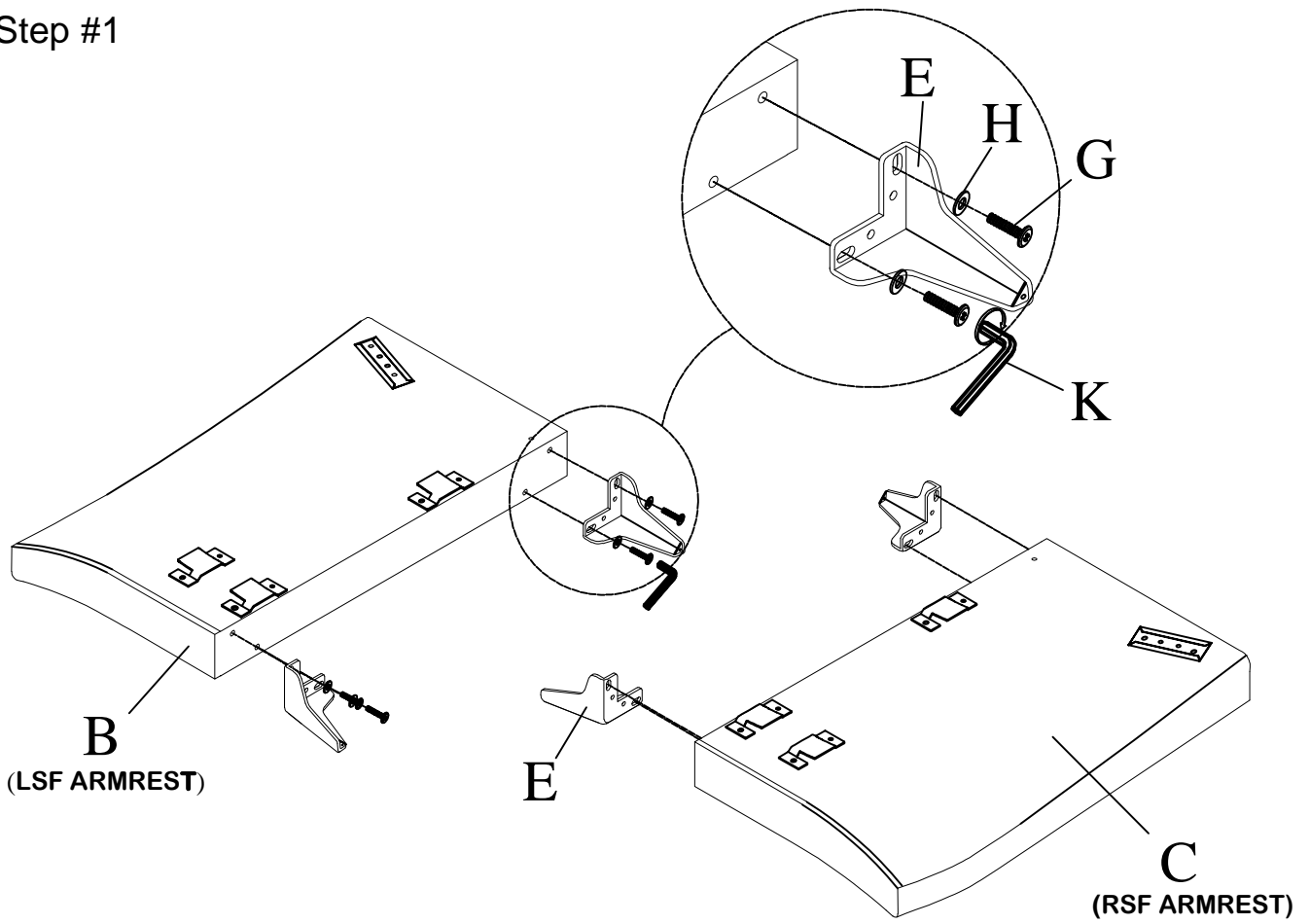

Step #2

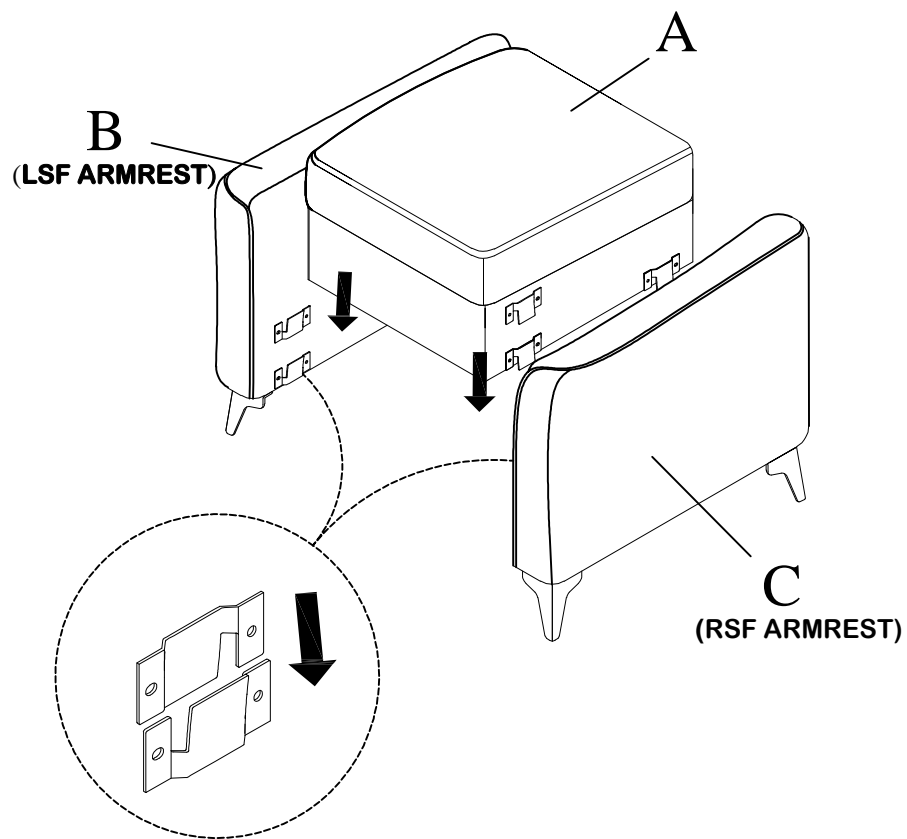

Step #3

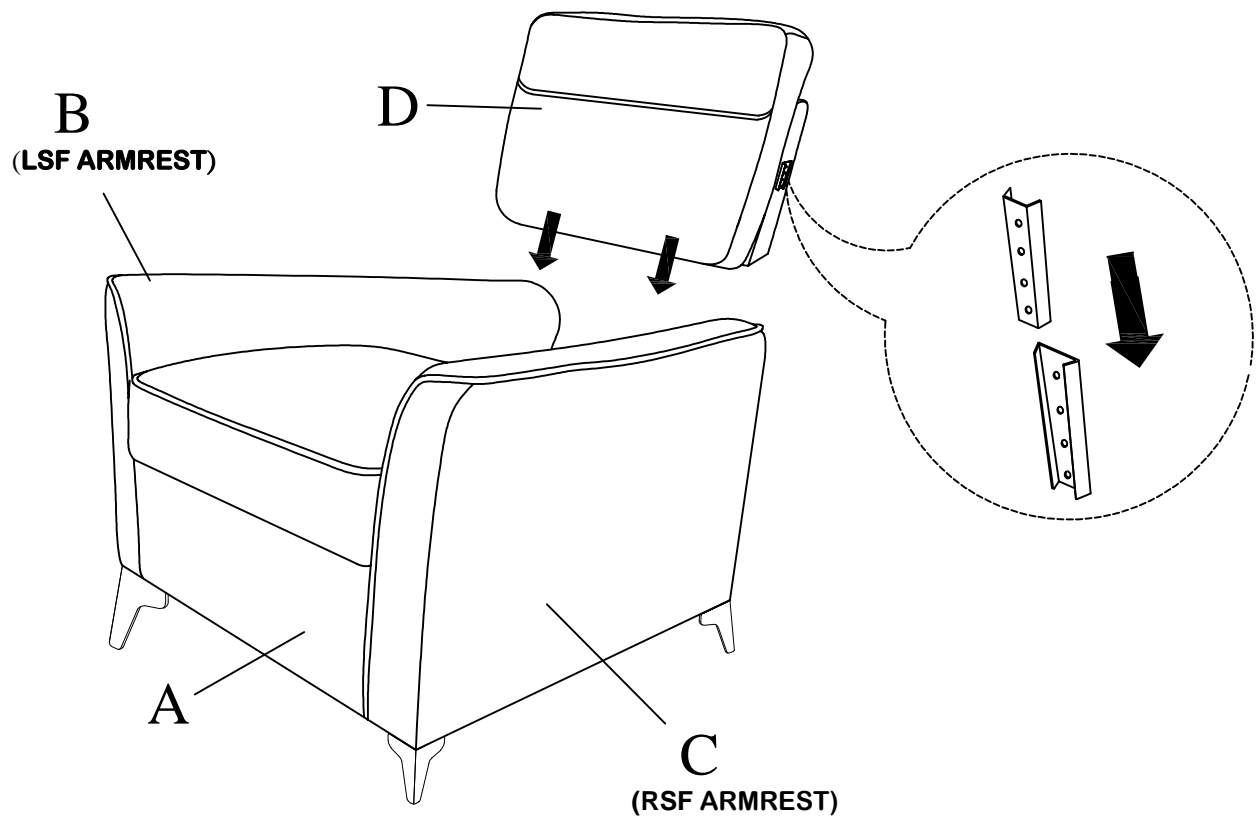

Step #4

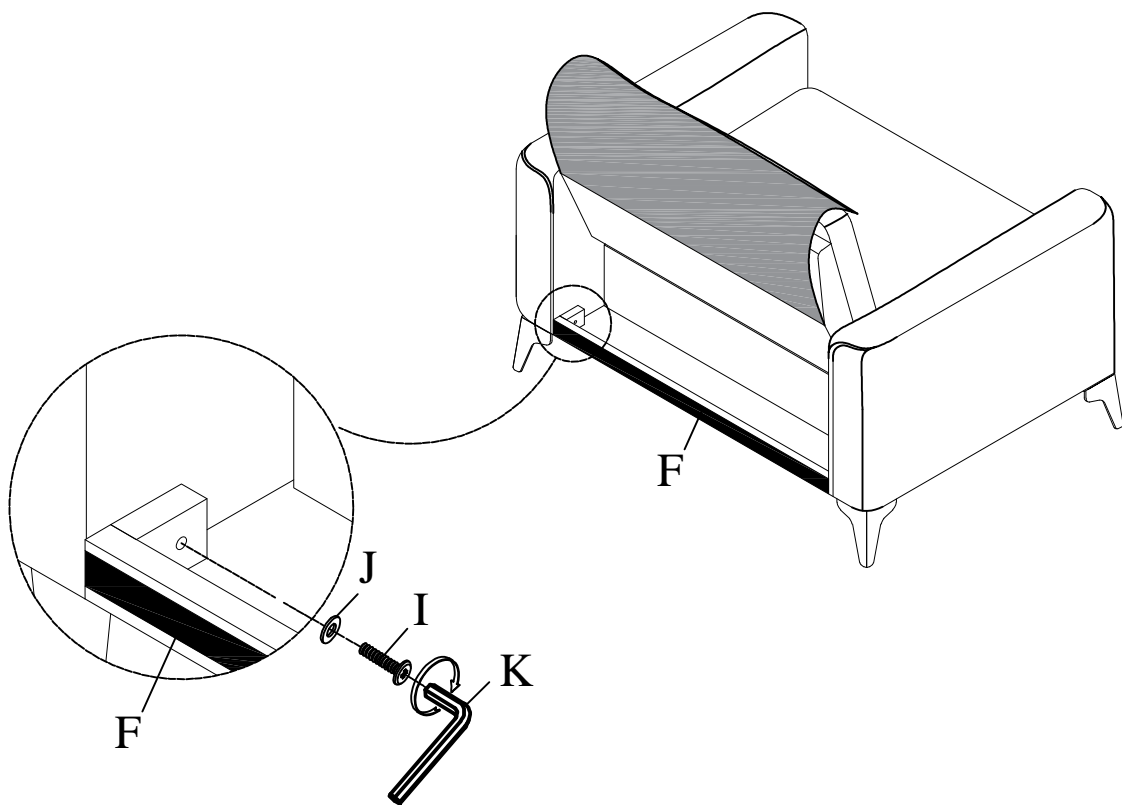

## Step #5

Assembly completed.

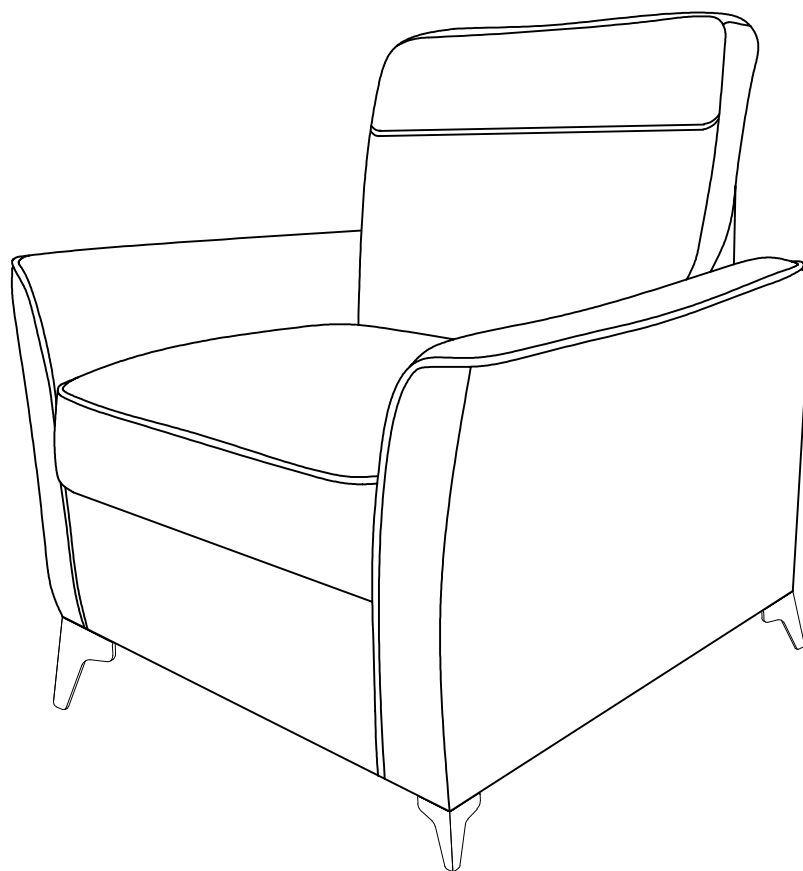

## Care Instruction for Textured Microfiber Furniture:

In order to maintain the original appearance of your textured microfiber, please follow below simple care procedures:

- Avoid exposing furniture directly to sunlight or heating and air conditioning outlets. Sunlight and/or exposure to heating and air conditioning outlets will fade/damage textured microfiber. Do not place your upholstered furniture too close to windows, radiators, or vents, and be sure to use windows, radiators, or vents.
- Vacuum or wipe with a soft cloth to remove dust.
- Hardware may loosen over time. Periodically check to make sure all connections are tight. Re-tighten if necessary.



For items use on wooden floor, hard surfaces or carpets, it is recommended to Install protective pads under all legs and supports to avoid/prevent from damages/scratches and discoloration.