

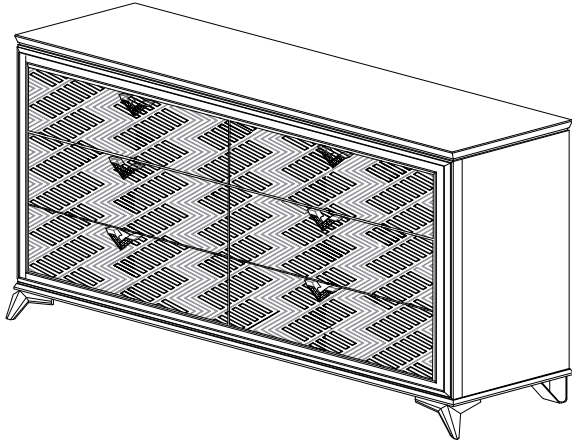

# ASSEMBLY INSTRUCTION

1383-5 - Dresser



Thank you for purchasing this product. Please take time to read and follow the instructions below. Check that you have all parts and hardware before assembly. Parts apparently missing are often found in the packing materials. If you do not have all the parts listed, have your dealer contact us and they will be sent to you immediately.

Merci d'avoir acheté ce produit. Veuillez lire et suivre les instructions ci-dessous. Vérifiez avant le montage que vous avez toutes les pièces et fixations. Les pièces qui semblent manquer se trouvent souvent dans les matériaux d'emballage. Si vous n'avez pas toutes les pièces de la liste, contactez votre détaillant et nous les enverrons immédiatement.







It is recommended to install protective pads under all legs and supports to avoid damage or scratches when placing furniture on a wood floor or other hard surface, and to limit indentation and prevent discoloration if placing on carpet.

Il est recommandé de placer des coussins protecteurs sous tous les pieds et toutes les bases des meubles pour éviter d'endommager ou d'égratigner les planchers en bois ou autres surfaces dures, et pour limiter l'empreinte et empêcher la décoloration quand les meubles reposent sur la moquette.



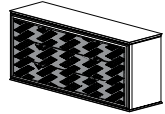







Hardware may loosen over time. Periodically check to make sure all connections are tight. Re-tighten if necessary. Le matériel peut se desserrer au fil du temps. Vérifiez périodiquement que toutes les connexions sont serrées. Serrer à nouveau si nécessaire.

## PART LIST#

NO	NAME	PART	QTY
A	Dresser		1pc
B	Acrylic Leg		2pcs
C	Metal Leg		2pcs
D	Center Leg		1pc

## HARDWARE LIST#

NO	NAME	PART	QTY
1	Allen Key 5mm		1pc
2	JCBB $\frac{5}{16}$ " x 35mm		4pcs
3	$\frac{5}{16}$ " Spring Washer		4pcs
4	$\frac{5}{16}$ " Flat Washer		4pcs
<b>HARDWARE LOCATED IN ACRYLIC LEG BOX</b>			

5	Allen Key 4mm		1pc
6	JCBC M6 x 20mm		4pcs
7	M6 Spring Washer		4pcs
8	M6 Flat Washer		4pcs
<b>HARDWARE LOCATED IN METAL LEG BOX</b>			



**DO NOT TIGHTEN BOLTS UNTIL COMPLETELY ASSEMBLED.**

**NE PAS SERRER LES BOULONS JUSQU'À CE QUE LE MONTAGE SOIT COMPLETMENT TERMINE.**

Remove Leg carton located in the drawer of the casegood. Remove and unwrap each Leg.

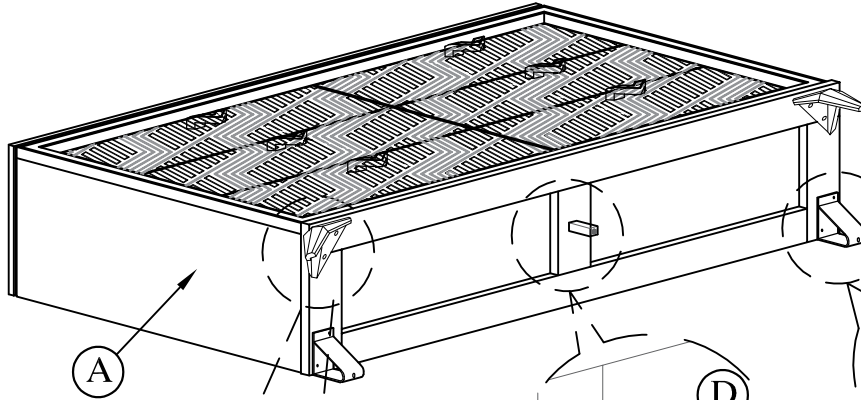
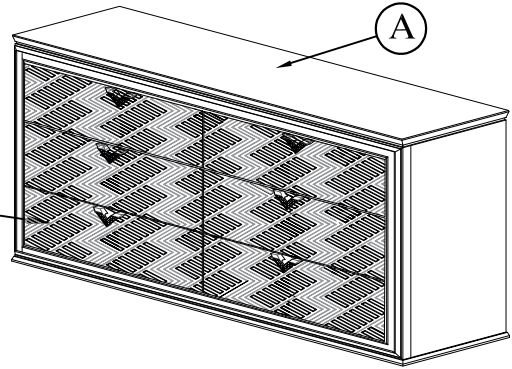
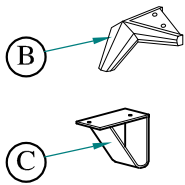

X2

**Step 2 :** Secure the (C) Metal Leg to the bottom of (A) Dresser tighten using (6) JCBC M6 x 20mm, (7) M6 Spring Washer & (8) M6 Flat Washer as a diagram shown.

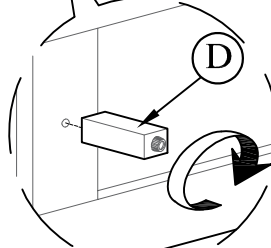
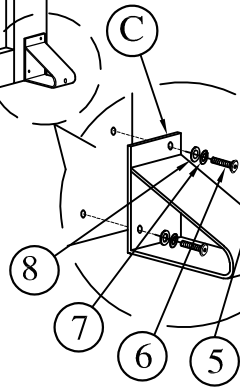



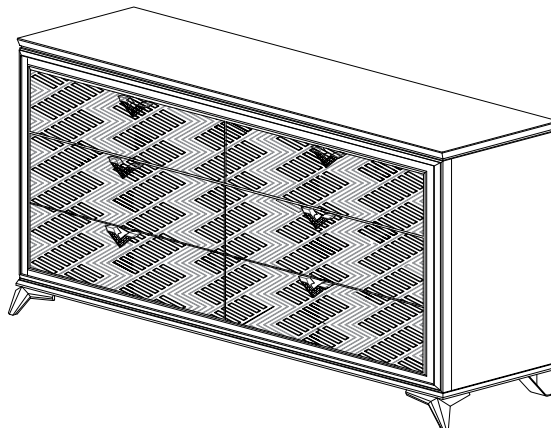
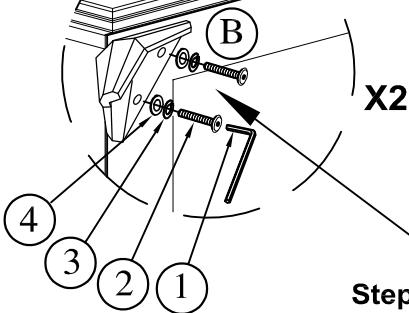

**Step 3 :** Secure the (D) Center Leg to the bottom of (A) Dresser as a diagram shown.

**Step 1 :** Secure the (B) Acrylic Leg to the bottom of (A) Dresser tighten using (2) JCBB  $\frac{5}{16}$ " x 35mm, (3)  $\frac{5}{16}$ " Spring Washer & (4)  $\frac{5}{16}$ " Flat Washer as a diagram shown.



**HARDWARE LIST (ANTI TIPPING) (ON upper back panel)**

NO	NAME	PART	QTY
A	Bracket		2pcs
B	Tie Wrap		1pc
C	Long Screw		1pc
D	Short Screw		1pc

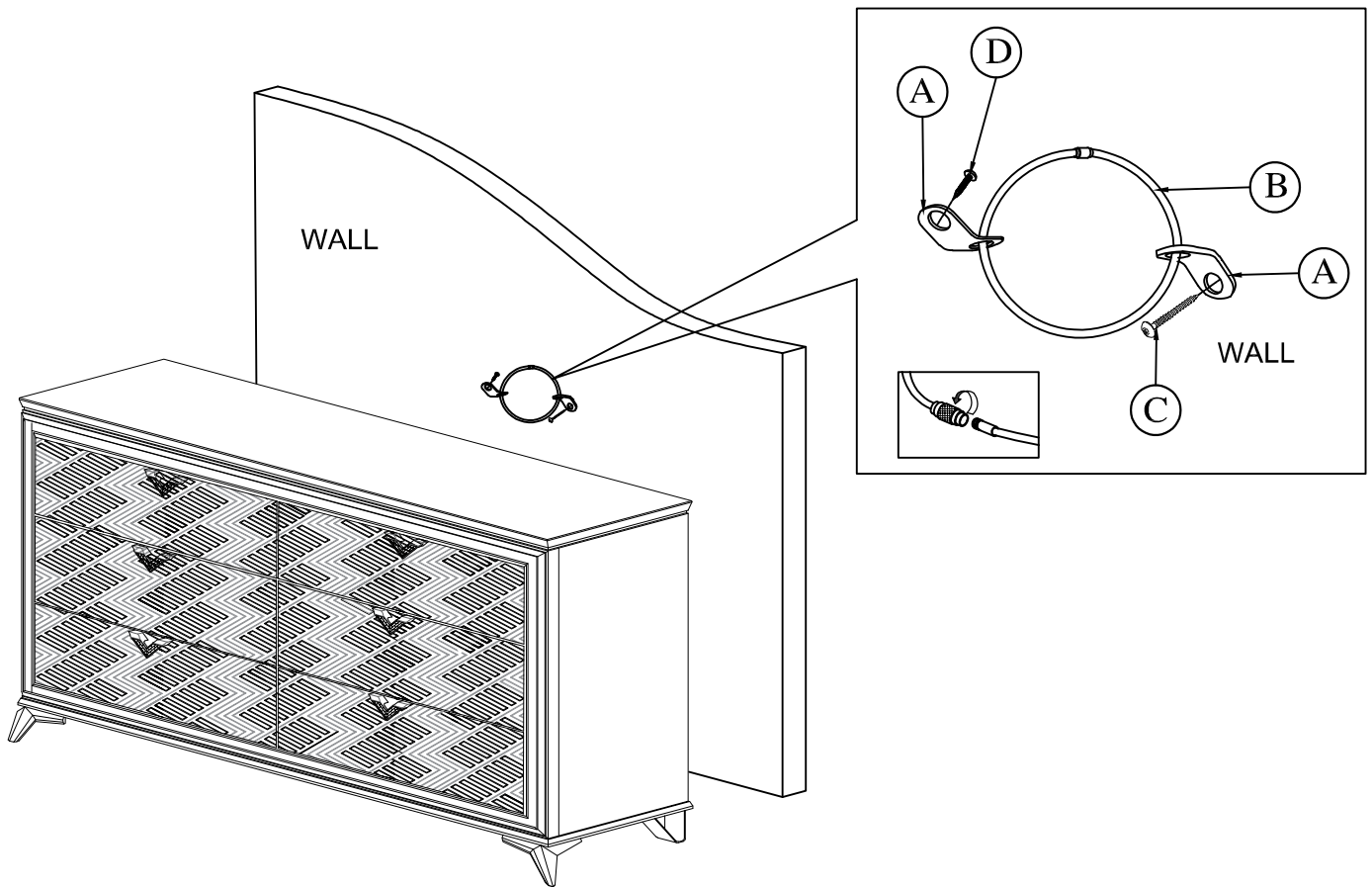

**Assembly completed**

**NOTE / REMARQUE**  
 Tipping Restraint hardware kit is included with this product. Refer to installation instruction in the hardware pack.  
 Une trousse anti-basculement est fourni avec ce produit. Veuillez vous référer aux instructions d'installation dans inclu dans la trousse de quincaillerie

\*ANTI-TIPPING HARDWARE PACK IS AT THE BACK PANEL  
 \*UNE TROUSSE ANTI-BASCULEMENT EST SITUÉ SUR LE PANNEAU ARRIÈRE.