



ASSEMBLY INSTRUCTION / INSTRUCTION D'ASSEMBLAGE

1616-14 Vanity Stool / Tabouret

Thank you for purchasing this product. Please take time to read and follow the instructions below. Check that you have all parts and hardware before assembly .

Merci d'avoir acheté ce produit de qualité. Vérifiez avant le montage que vous avez toutes les pièces et fixations. Les pièces qui semblent manquer se trouvent souvent dans les matériaux d'emballage.



It is recommended to install protective pads under all legs and supports to avoid damage or scratches when placing furniture on a wood floor or other hard surface, and to limit indentation and prevent discoloration if placing on carpet.

Il est recommandé de placer des coussins protecteurs sous tous les pieds et toutes les bases des meubles pour éviter d'endommager ou d'égratigner les planchers en bois ou autres surfaces dures, et pour limiter l'empreinte et empêcher la décoloration quand les meubles reposent sur la moquette.





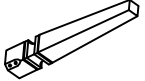

DO NOT TIGHTEN BOLTS UNTIL COMPLETELY ASSEMBLED.

NE PAS SERRER LES BOULONS JUSQU'À CE QUE LE MONTAGE SOIT COMPLETMENT TERMINE.

PART LIST / LISTE DE PIÈCES

NO	NAME	PART	QTY
A	Seat frame with cushion / Cadre de Siège avec coussin		1pc
B	Leg / Pied		4pcs

HARDWARE LIST / LISTE DE QUINCAILLERIE

NO	NAME	PART	QTY
1	Allen Key / Clè Allen - M4		1pc
2	JCBC / Boulon - M6 x 45mm		8pcs
3	Spring Washer / Rondelle D'arrêt - M6 x 13mm		8pcs
4	Flat Washer / Rondelle Plate - 1/4 " x 19mm		8pcs

HARDWARE SET IS IN 1616-14 FOR ASSEMBLY

Step 1 / Étape 1 :

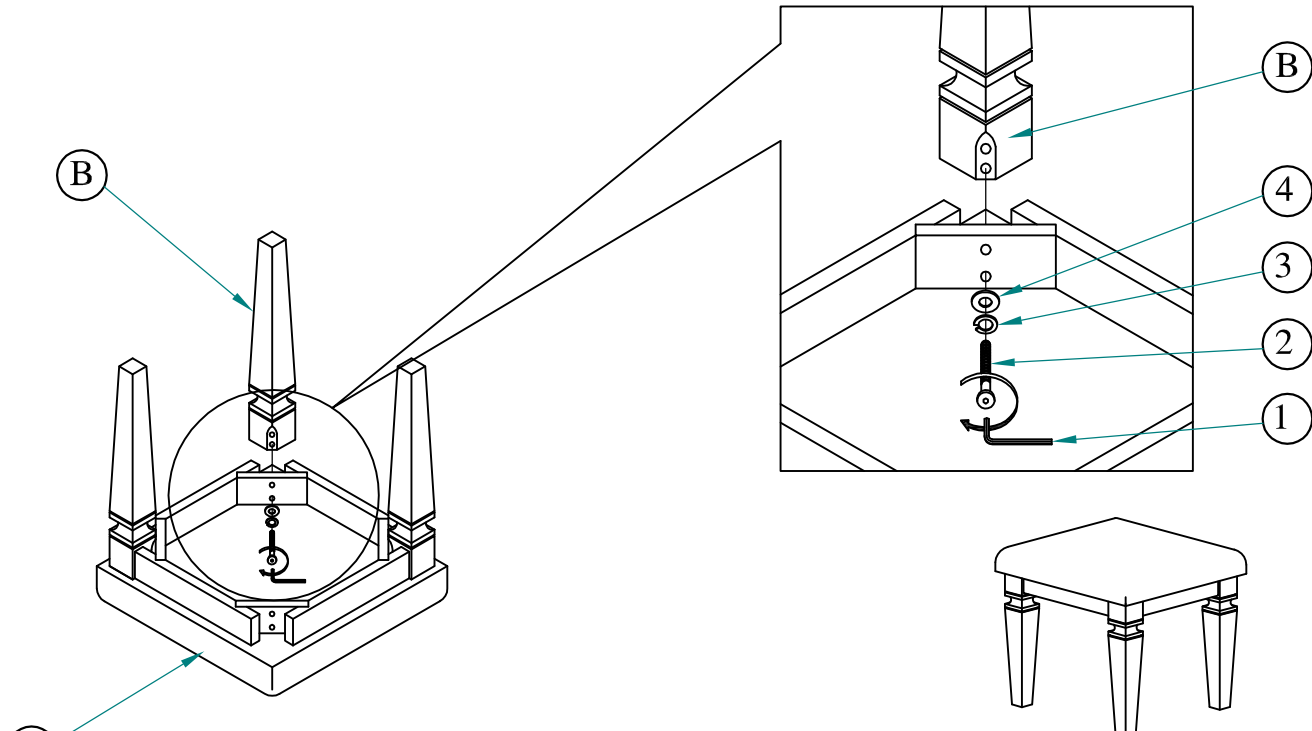

Assembly completed /
Assemblage completé