

ASSEMBLY INSTRUCTION

2601-36(3A)/2601-36 COUNTER HEIGHT TABLE, FAUX MARBLE TOP

PART LIST:

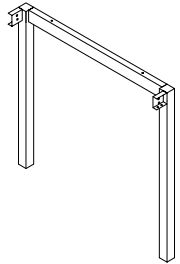

Table Leg Frame
2 PCS

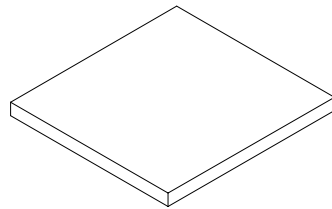

Table Top
1 PC

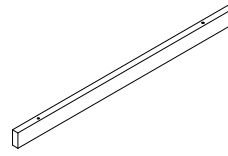
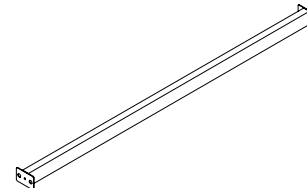





Table Apron
2 PCS



Cross Bar
1 PC

HARDWARE LIST

| | | | | |
|----------|---|-------------|-----------|--------|
| A |  | Bolt | 1/4"*16mm | 20 PCS |
| B |  | Screw | 5mm*70mm | 8 PCS |
| C |  | L-Allen Key | 4mm | 1 PC |

STEP 1

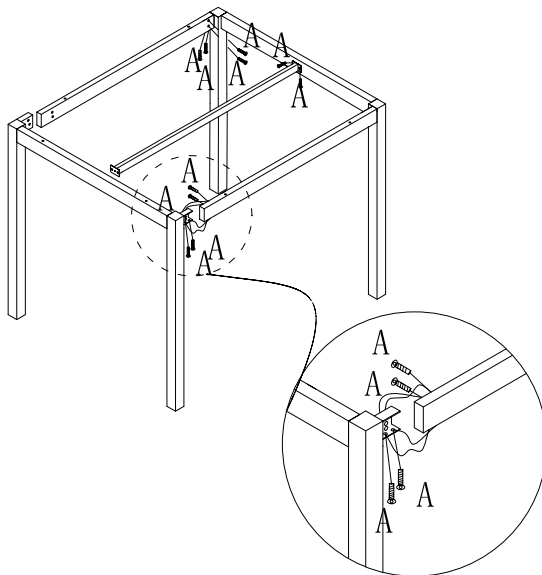

STEP 2

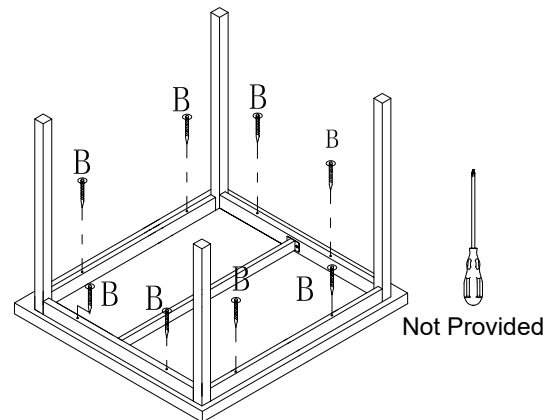

COMPLETED

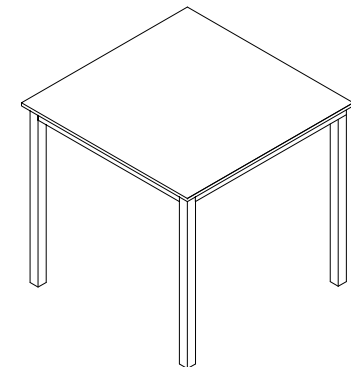



(1) Align the table leg frame to apron and tighten with bolts.

(2) Place the table top on the smooth and stable carpeted or padded surface. Tighten the apron to table top with screws.

Thank you for purchasing the product. Please take time to read and follow the instruction below. Check that you have all parts and hardware before assembly. Parts apparently missing are often found in the packing materials. If you do not have all the parts listed, have your dealer contact us and they will be sent to you immediately.

Merci d'avoir acheté ce produit. Veuillez lire et suivre les instructions ci-dessous. Vérifiez avant le montage que vous avez toutes les pièces et fixations. Les pièces qui semblent manquer se trouvent souvent dans les matériaux d'emballage. Si vous n'avez pas toutes les pièces de la liste, demandez à votre détaillant et nous vous les enverrons immédiatement.

 It is recommended to install protective pads under all legs and support to avoid damage or scratches when placing furniture on a wood floor or other hard surface, and to limit indentation and prevent discoloration if placing on carpet.

 Il est recommandé de placer des coussins protecteurs sous tous les pieds et toutes les bases des meubles pour éviter d'endommager ou d'égratigner les planchers en bois ou autres surfaces dures, et pour limiter l'empreinte et empêcher la décoloration quand les meubles reposent sur la moquette.

 Hardware may loosen over time. Periodically check to make sure all connections are tight. Retighten if necessary.

 Le matériel peut se desserrer au fil du temps. Vérifiez périodiquement que toutes les connexions sont serrées. Serrer à nouveau si nécessaire.

CAUTION!/CAUTION:

- (1) DO NOT FULLY - TIGHTEN THE NUTS OR BOLTS INITIALLY UNTIL ALL THE NUTS AND BOLTS ARE IN PLACE. (TO AVOID CAUSING DAMAGES TO THE THREAD, DO NOT OVER TIGHTEN THE NUTS OR BOLTS.) / NE PAS SERRER LES BOULONS JUSQU'À CE QUE LE MONTAGE SOIT COMPLÈTMENT TERMINÉ.
- (2) KEEP ALL HARDWARE PARTS OUT OF REACH OF CHILDREN. / GARDER TOUTES LES PIÈCES HORS DE LA PORTÉE D'ENFANTS.