



H O M E E L E G A N C E









Assembly Instruction

ITEM NO.: 9644BGY-3
SOFA WITH 2 PILLOWS

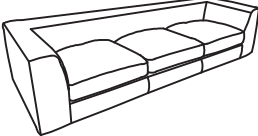

Note: Do not use power tools for assembly. Power tools increase the risk of over tightening which lead to spliting or cracking the wood.

Component list

No	Drawing	Qty	Description
A		1	LSF BACK CUSHION
B		1	MIDDLE BACK CUSHION
C		1	RSF BACK CUSHION
D		1	SEAT
E		4	PLASTIC LEG 5"*4"*6"
F		16	BOLT 5/16 "-10*1/2-3/5"L
G		1	ALLEN KEY M6*65mm
H		1	CENTER SUPPORT LEG 2.5"*2.5"*6"
I		2	PILLOW 18"*18"*6"

Step #1

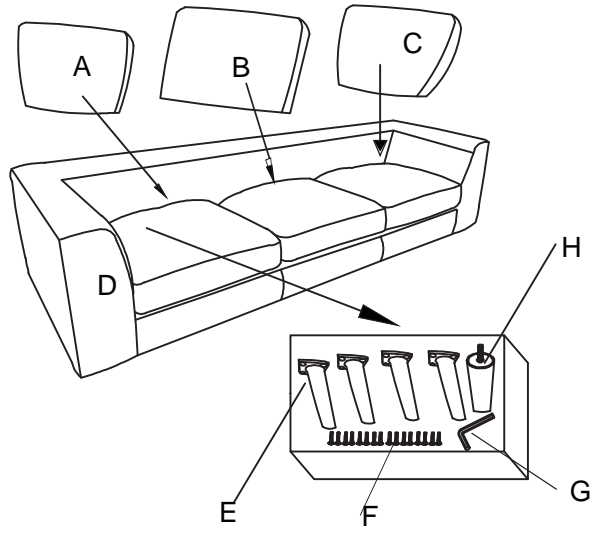

Step #2

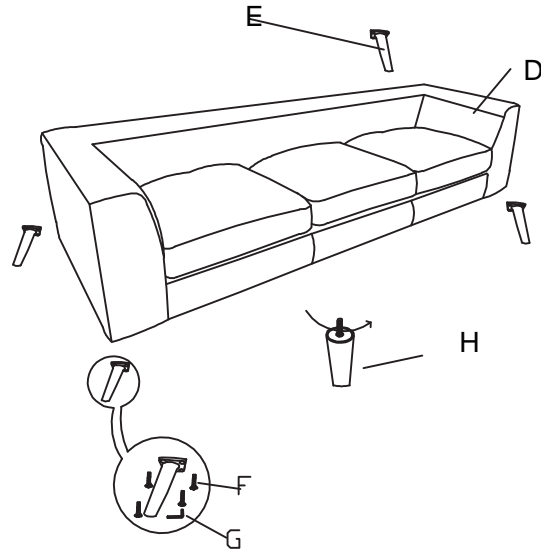

Step #3

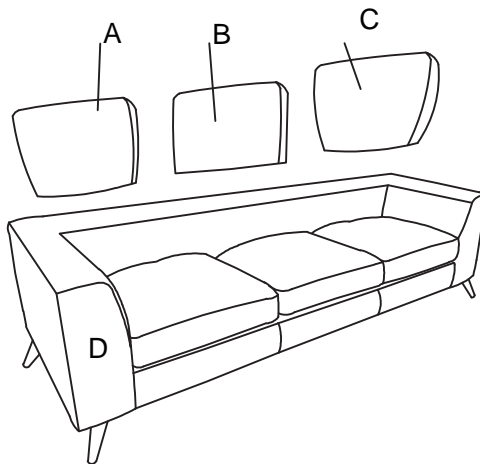

Step #4

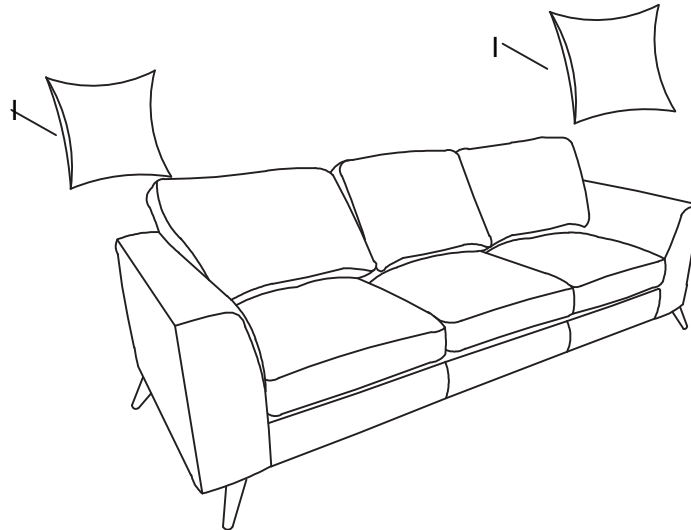

Step #5

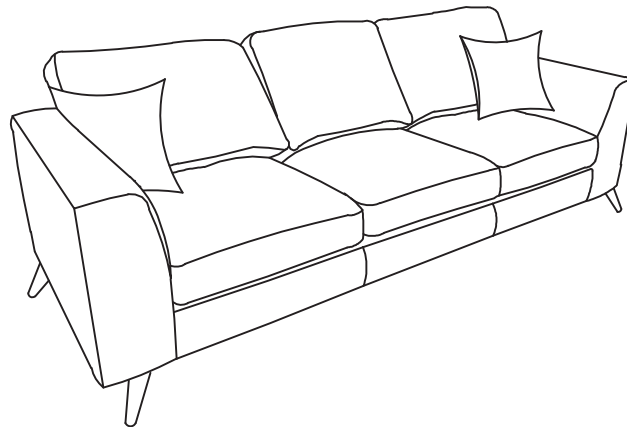

Care Instruction for CHENILLE Furniture

In order to maintain the original appearance of your CHENILLE Furniture please follow below simple care procedures:

- Avoid exposing furniture directly to sunlight or heating and air conditioning outlets. Sunlight and or exposure to heating and air conditioning outlets will fade/damage CHENILLE.
- Vacuum or wipe with a soft cloth to remove dust.
- Hardware may loosen over time. Periodically check to make sure all connection are tight, Re-tighten if necessary.



For items use on wooden floor, hard surfaces or carpets, it is recommended to install protective pads under all legs and supports to avoid/prevent from damages/scratches and discoloration.