

# Assembly Instructions

## ITEM: SH3411

Sofa Power with power headrest

Love Seat w/console

Power Recliner with power headrest

SKU:

SH3411FMT-3PWH SH3411FMT-2PWH SH3411FMT-1PWH

SH3411FSN-3PWH SH3411FSN-2PWH SH3411FSN-1PWH

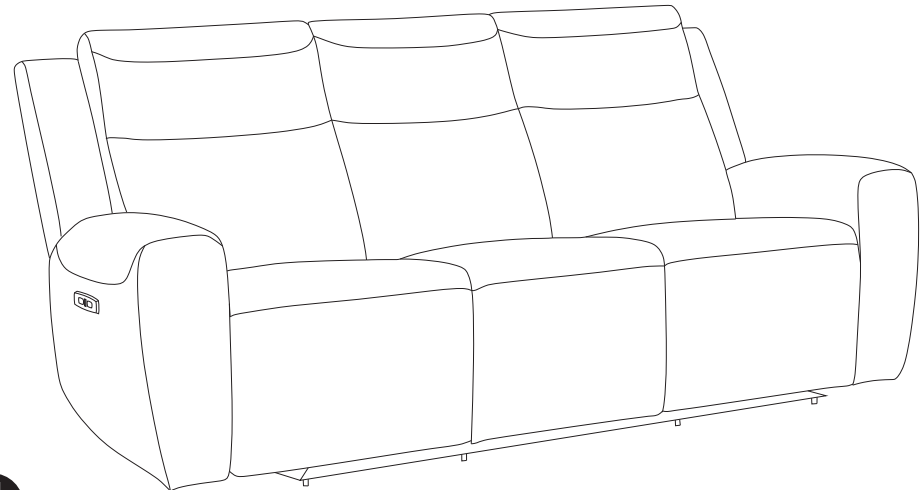
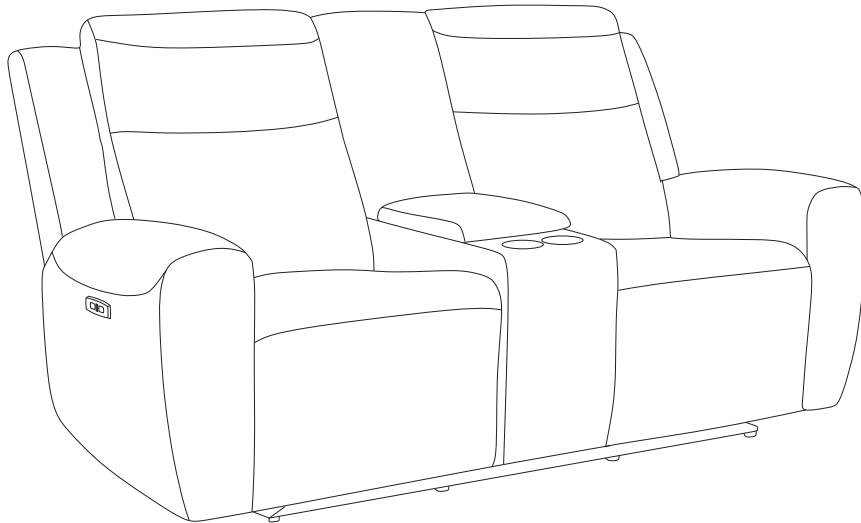
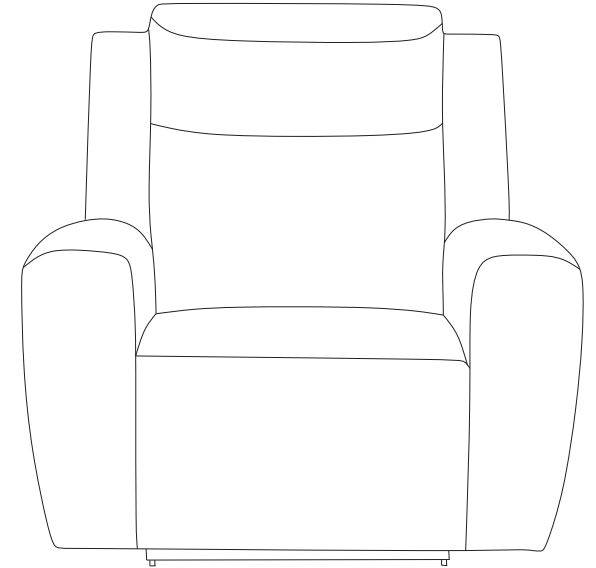

# Preparations

## Pre-Assembly Preparations

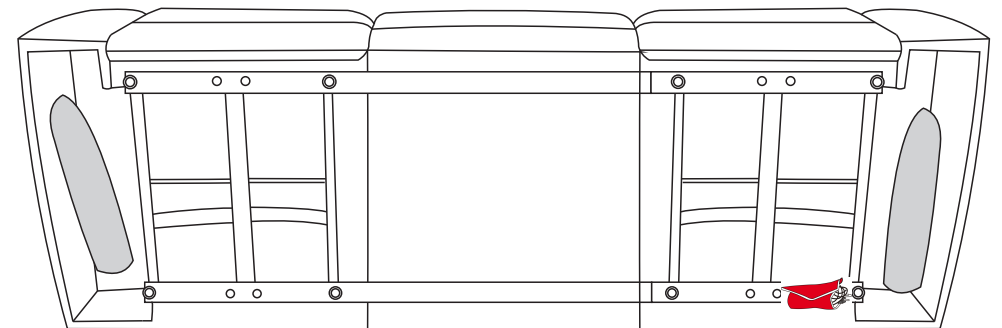
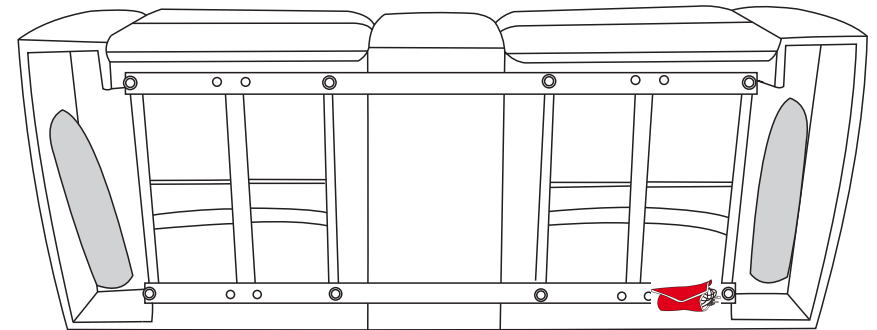
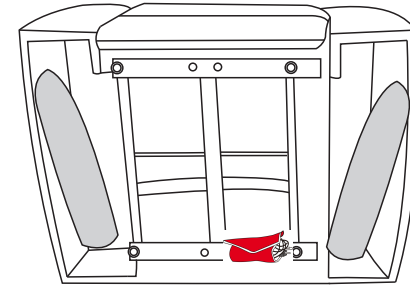

Thank you for choosing our product, please read this instruction carefully before assembly.

First, to avoid damage to the product, please make sure you have a large and clean place to assemble. Second, please check all the parts according to the list on the next page.

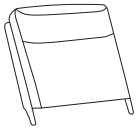
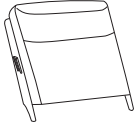

# List of Parts

## PART LIST

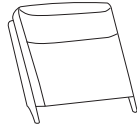
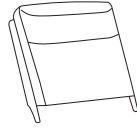
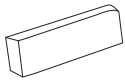
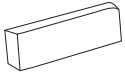
NO	Sketch	Description	Quantity Recliner	Quantity Loveseat	Quantity Sofa
A		BACK	1		
B		BACK(L)		1	1
C		BACK (Console)		1	
D		BACK(R)		1	1
E		BACK(M)			1
G		Wing (L)	1	1	1
H		Wing (R)	1	1	1

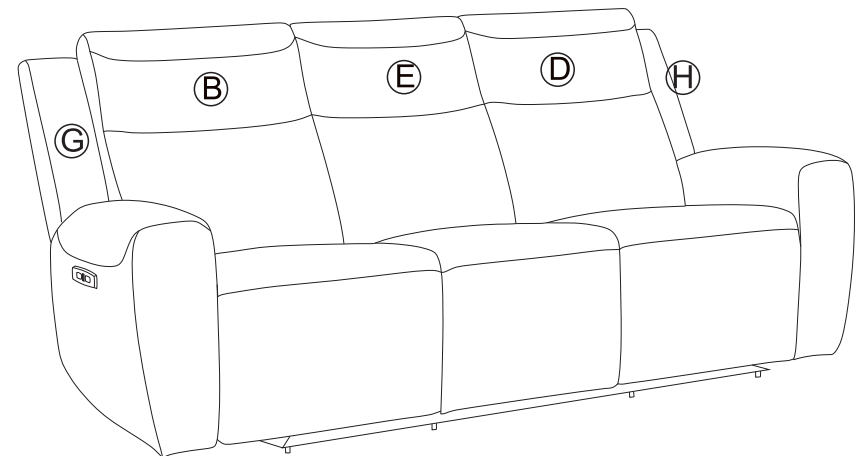
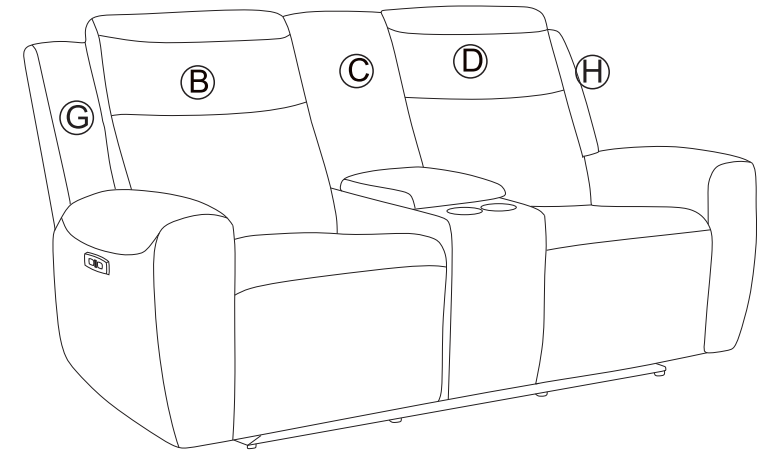
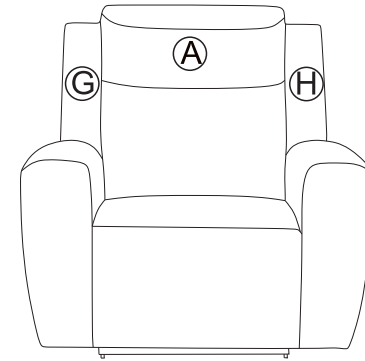

# ASSEMBLY INSTRUCTIONS

## STEP 1

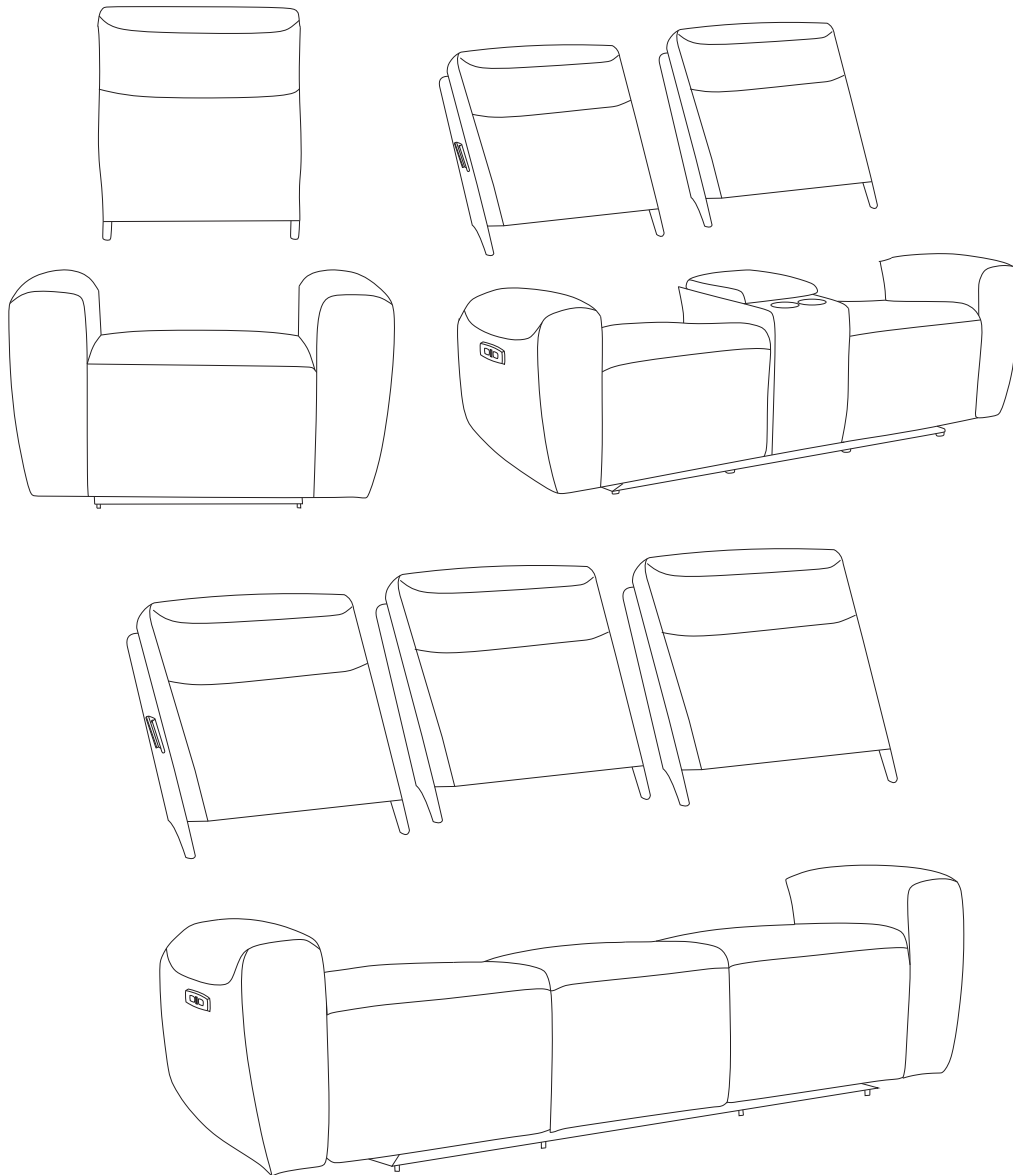

## Attaching the Backrest to the Body

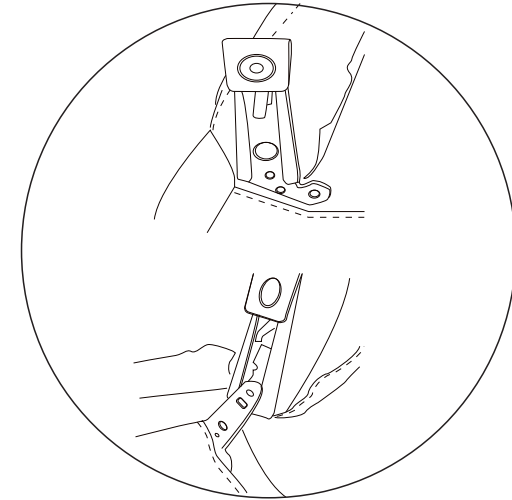

Please align the connectors of the backrest and seat according to the diagram, then press down to ensure a perfect fit.

# ASSEMBLY INSTRUCTIONS

## STEP 2

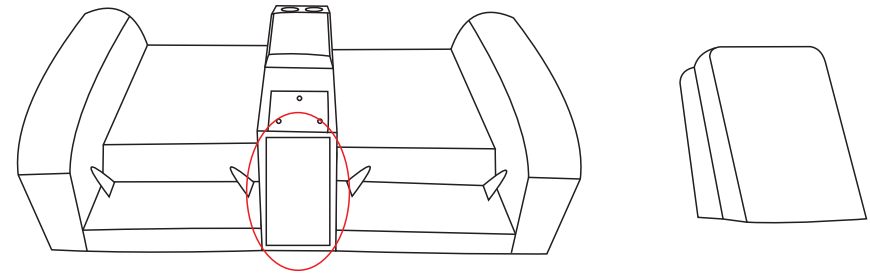
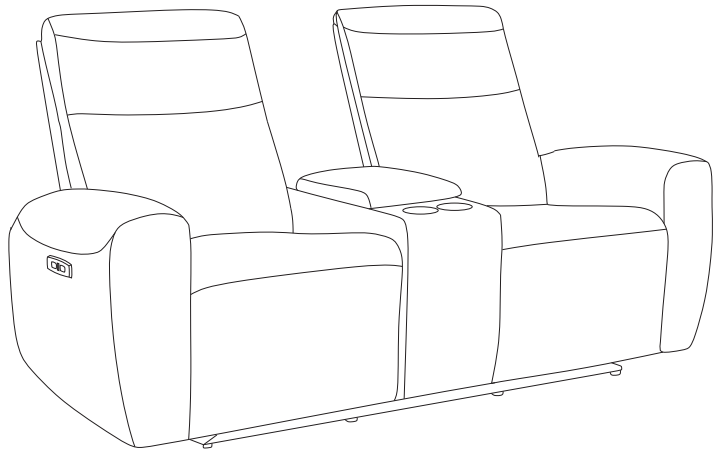

Please Take out the Back(Console) from the bottom of the console  
Align the holes of the Back and console, then  
tighten the screws in a clockwise direction.

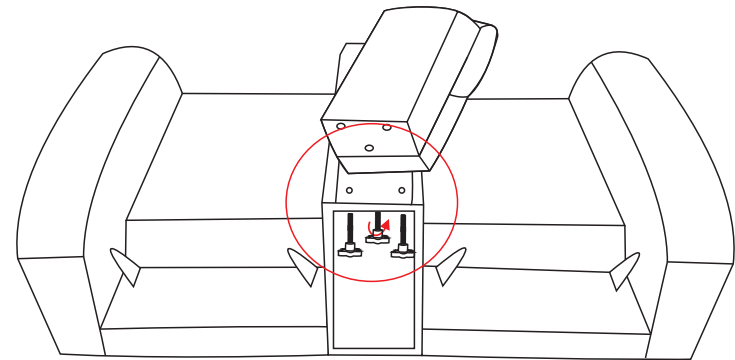

# ASSEMBLY INSTRUCTIONS

## STEP 3

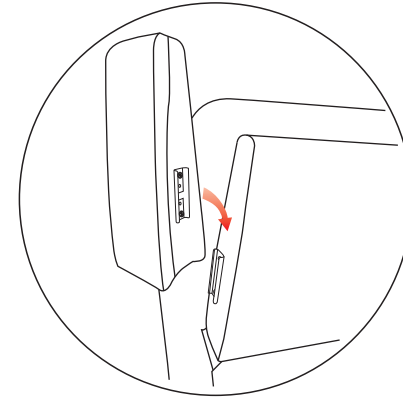
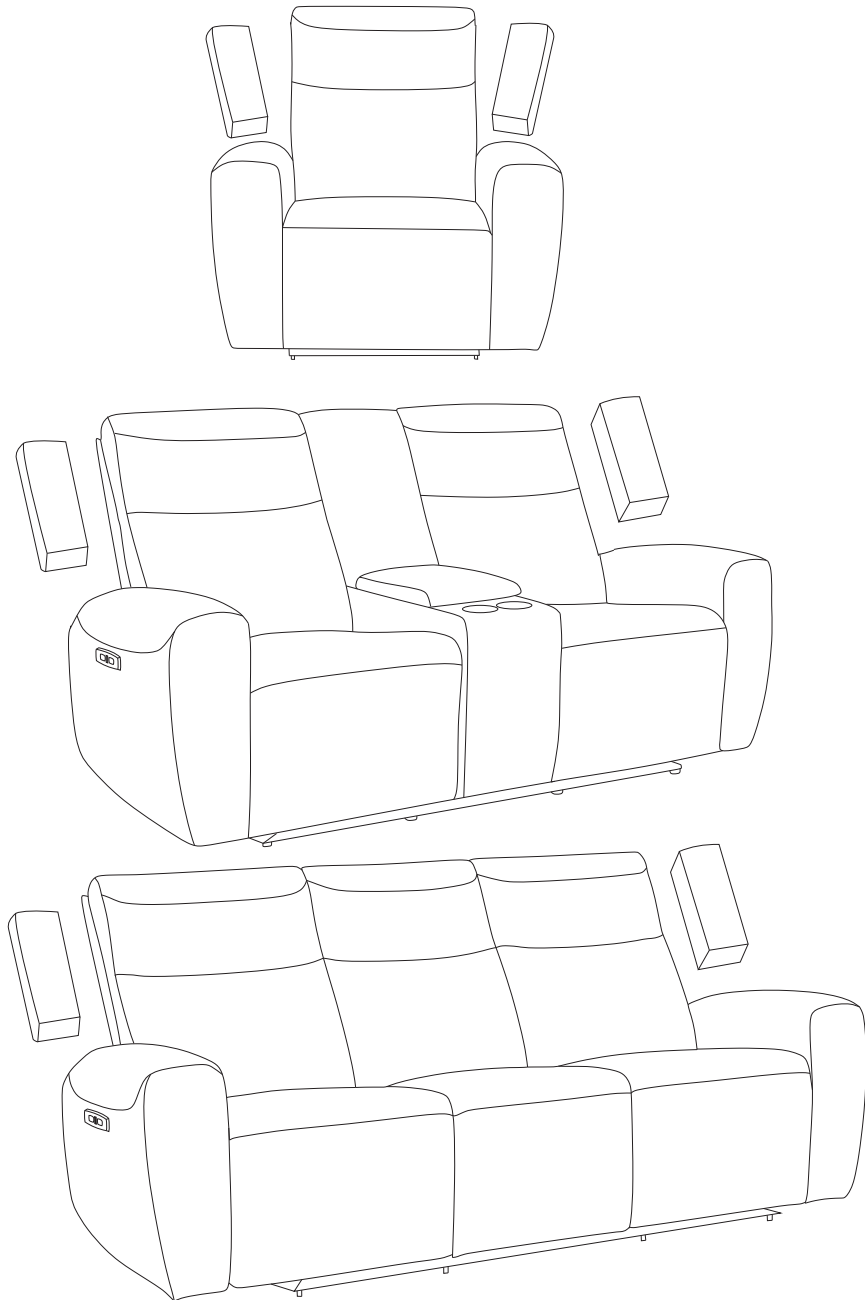

Please connect the backrest and the wing according to the diagram.

# ASSEMBLY INSTRUCTIONS

## STEP 4/5/6

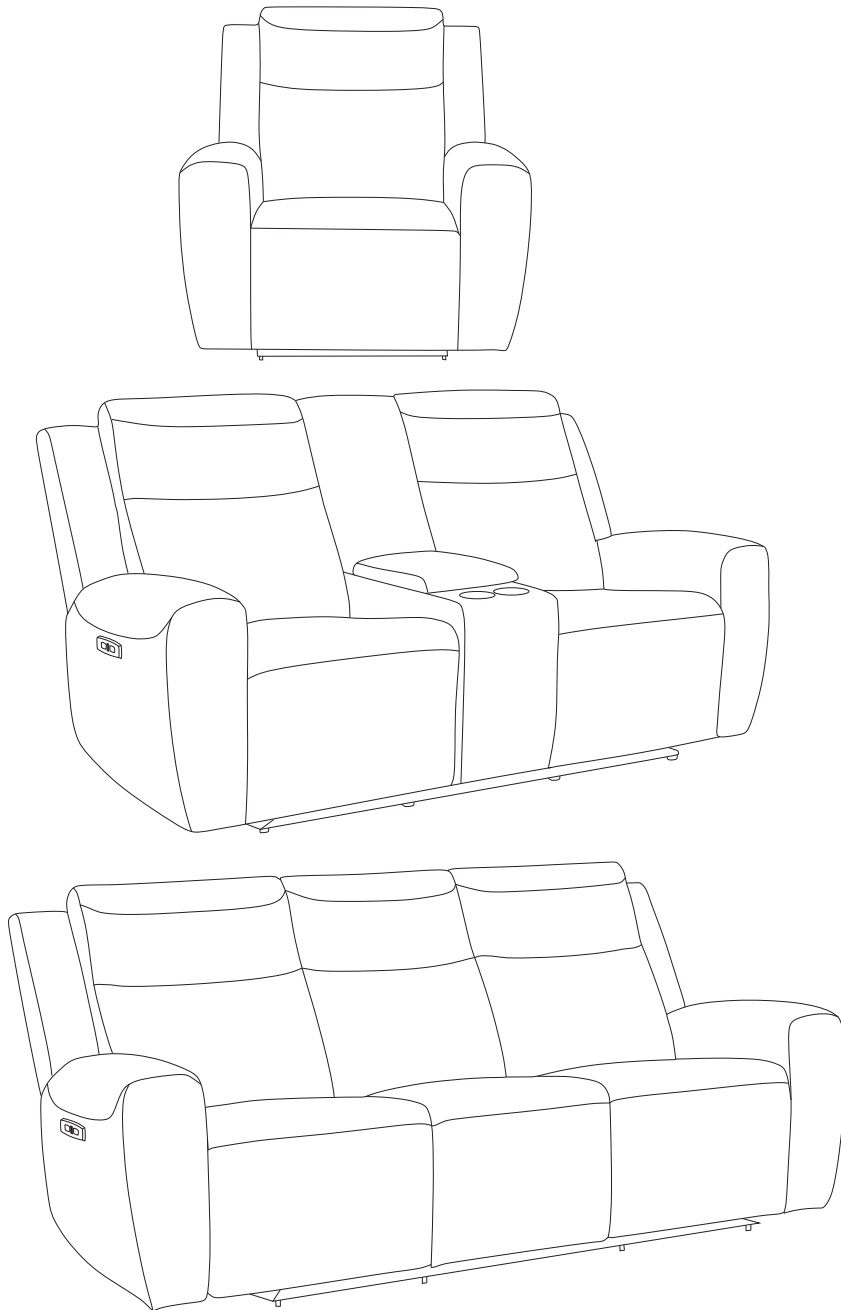

## Connect the power port

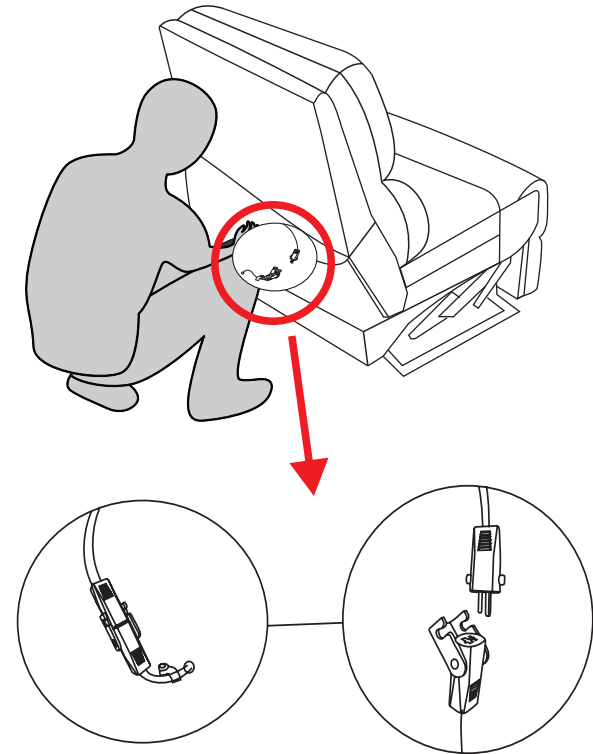

Please check and connect the power port of seat motor and headrest motor, make sure secure the protector.

# ASSEMBLY INSTRUCTIONS

## Fasten the Velcro

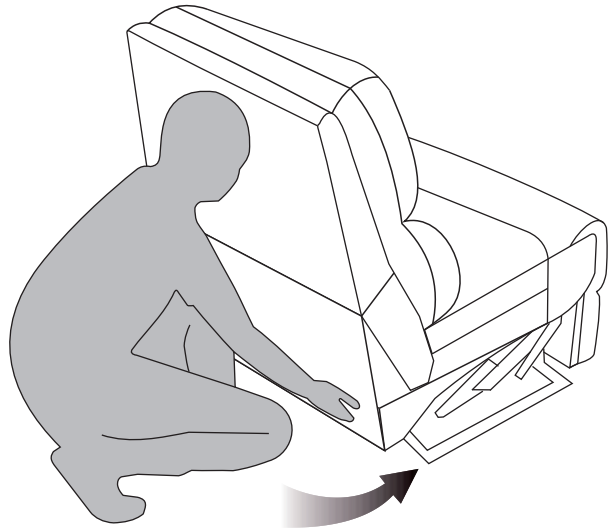

Attach the Velcro on the back of the sofa

## Connect the power supply

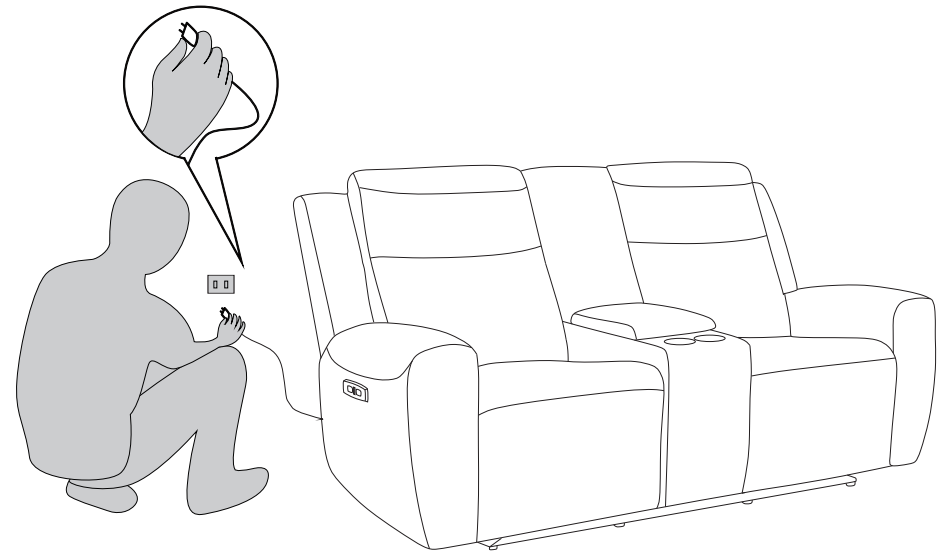



# POWER CONNECTIONS

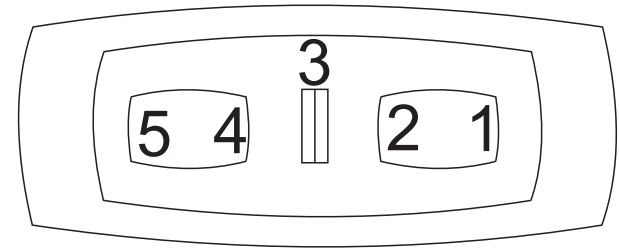
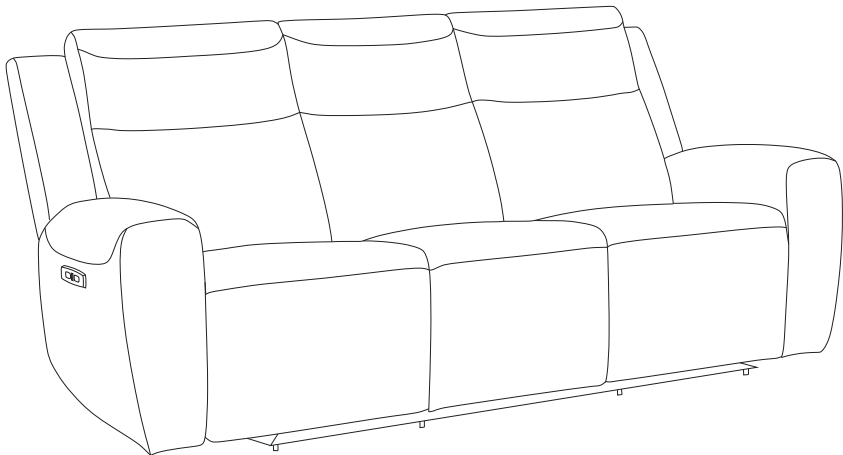
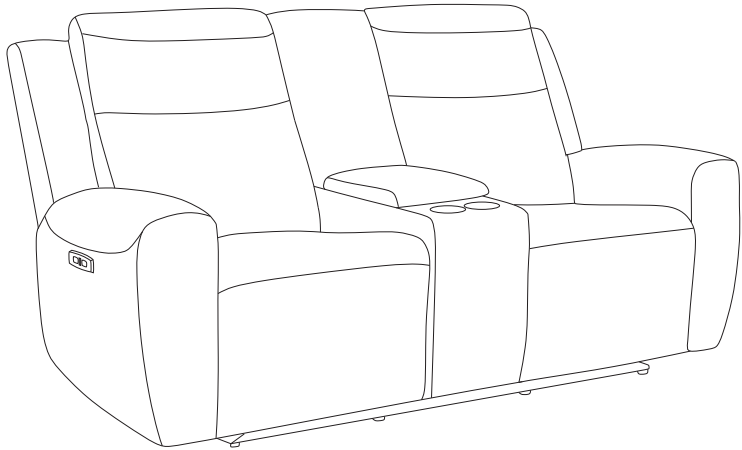
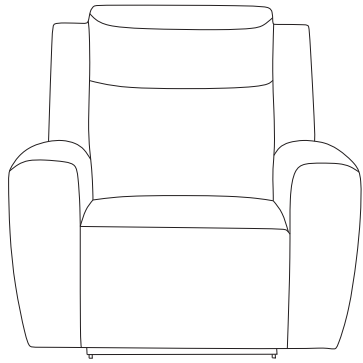

Location	Function
1	Seat Forward
2	Home Button
3	USB Port
4	Headrest Forward
5	Headrest Backward