

# Assembly Instructions

## ITEM: SH3412

Power Left Arm Recliner, power headrest

Power Right Arm Recliner, power headrest

Power Armless Chair Recliner, power headrest

Armless Chair

Corner Wedge

Console

SKU:

SH3412CHR-LRPWH SH3412CHR-RRPWH SH3412CHR-ARPWH

SH3412CHR-AC SH3412CHR-CR SH3412CHR-CN

SH3412BRW-LRPWH SH3412BRW-RRPWH SH3412BRW-ARPWH

SH3412BRW-AC SH3412BRW-CR SH3412BRW-CN

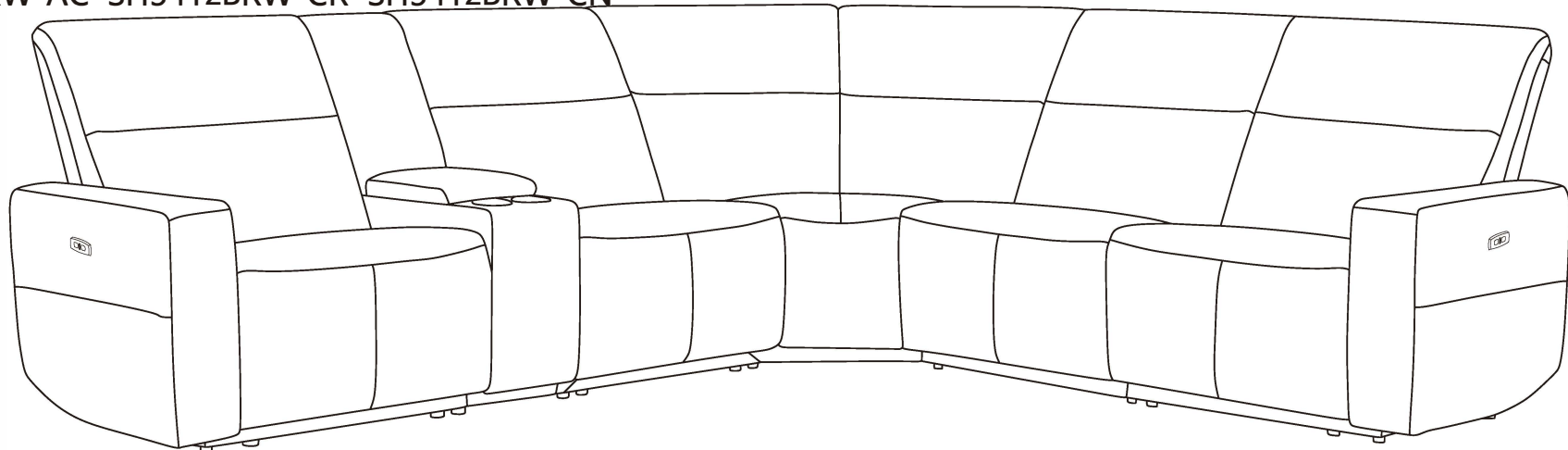

# Preparations

## Pre-Assembly Preparations

Thank you for choosing our product, please read this instruction carefully before assembly.

First, to avoid damage to the product, please make sure you have a large and clean place to assemble. Second, please check all the parts according to the list on the next page.

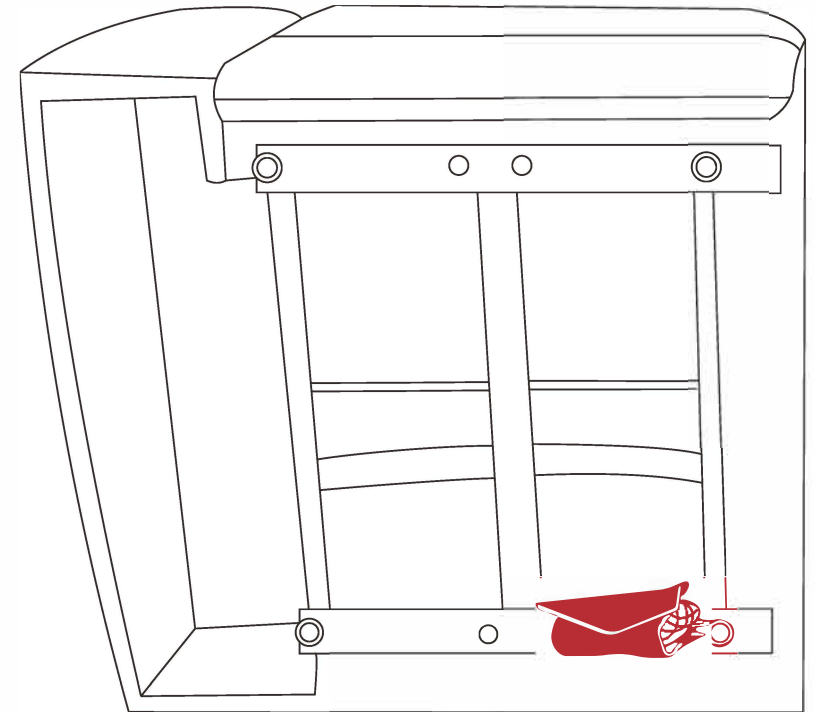

# List of Parts

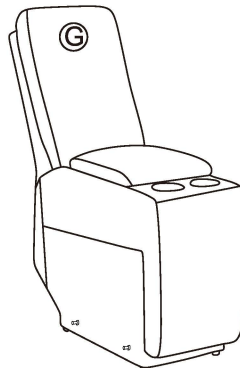
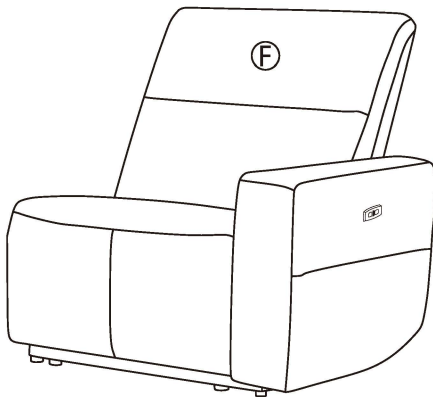
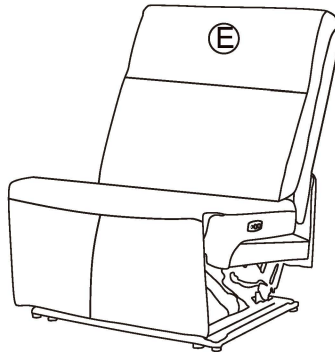
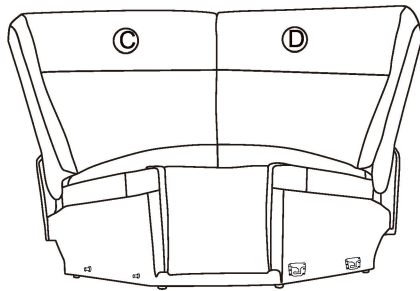
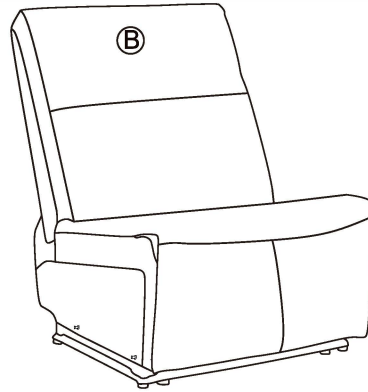
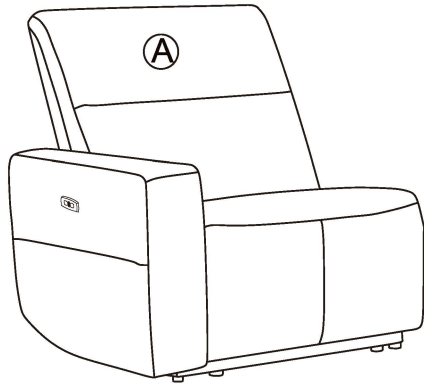

## List of Parts

NO.	Schetch	Description	QTY
A		Back (L)	1
B		Back(Armless Chair)	1
C		Back (Corner L)	1
D		Back (Corner R)	1
E		Back(Armless Recliner)	1
F		Back (R)	1
G		Back (Console)	1

# ASSEMBLY INSTRUCTIONS

## STEP 1 Attaching the Backrest to the Body

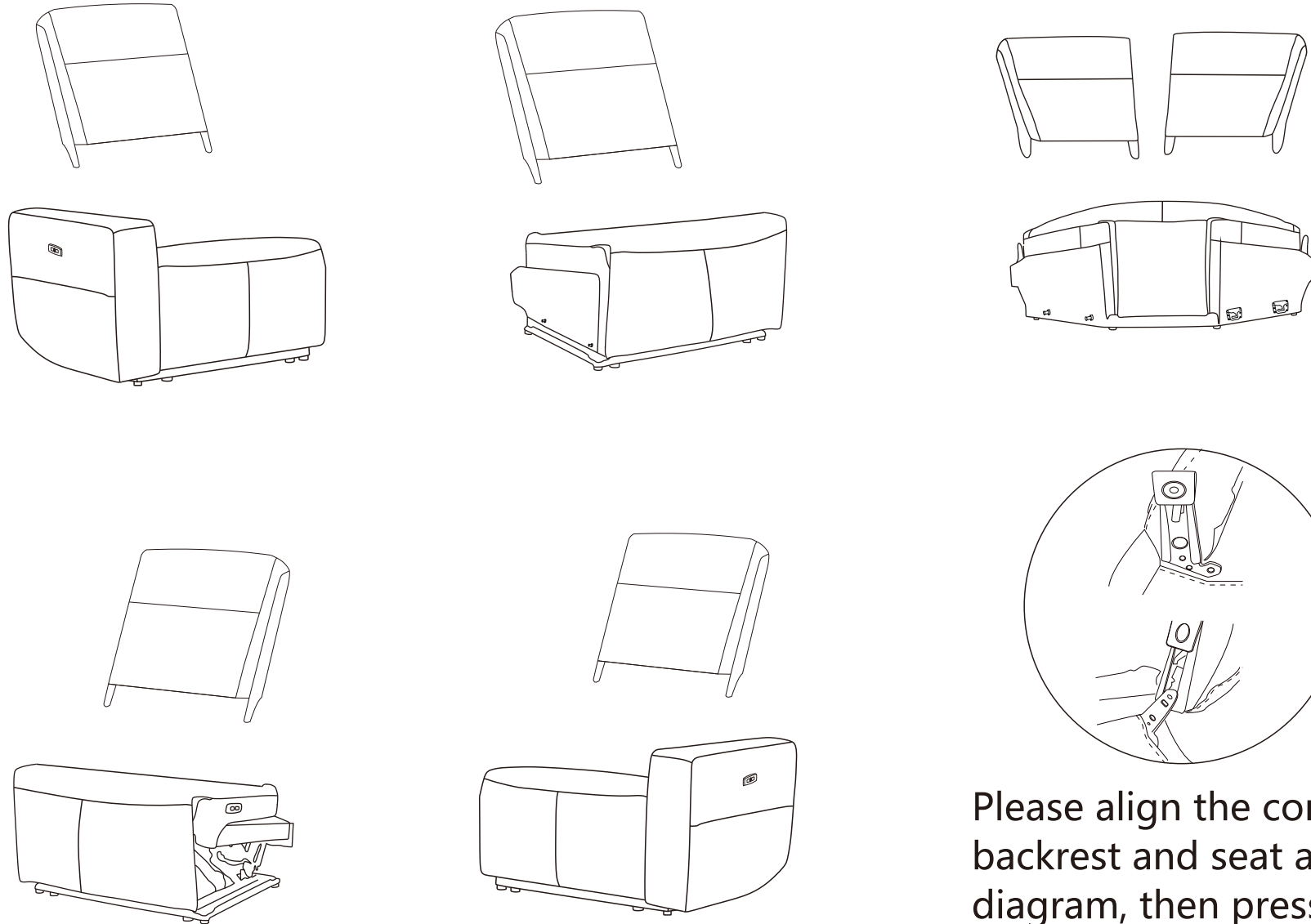

Please align the connectors of the backrest and seat according to the diagram, then press down to ensure a perfect fit.

# ASSEMBLY INSTRUCTIONS

## STEP 2

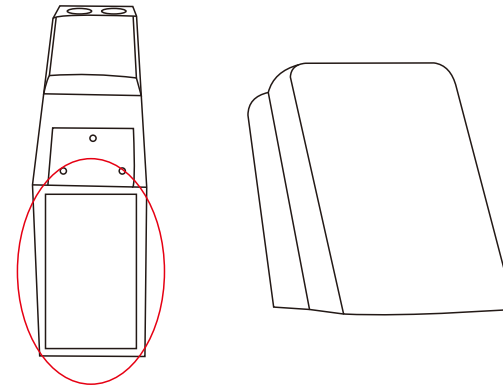
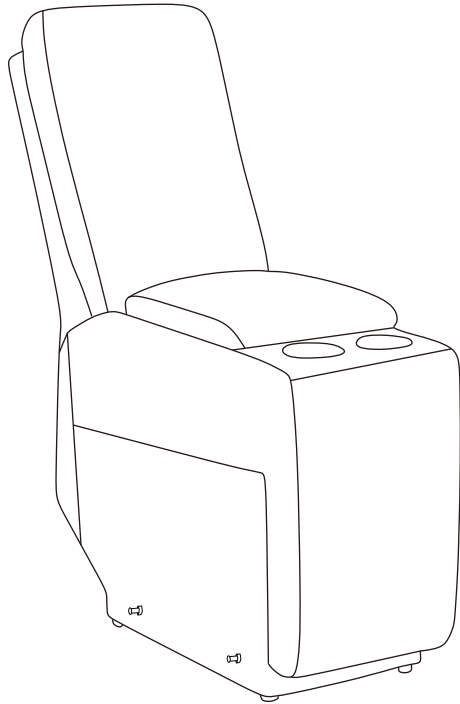

Please take out the Back(Console) from the bottom of the console.  
Align the holes of the Back and console,  
then tighten the screws in a clockwise direction.

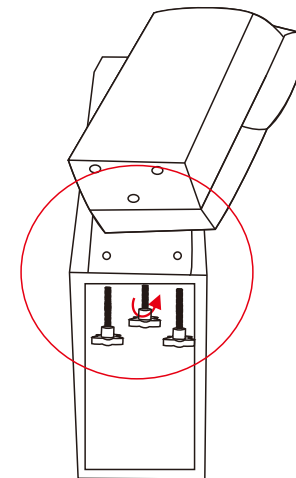

# ASSEMBLY INSTRUCTIONS

## STEP 3/4/5

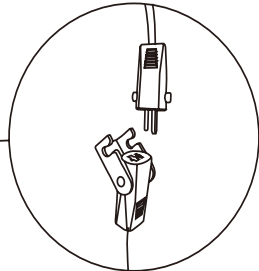
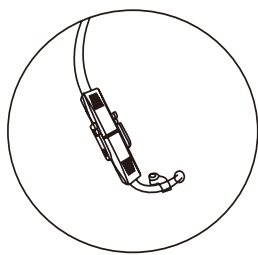
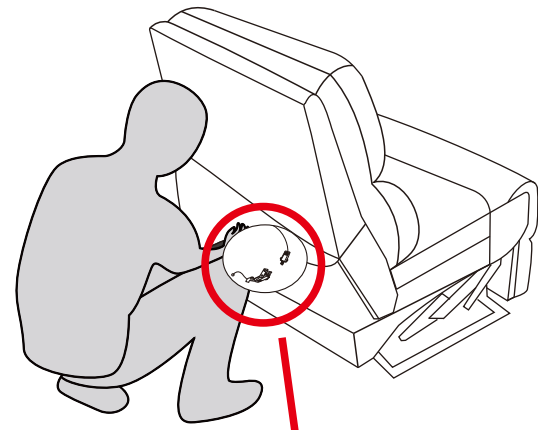
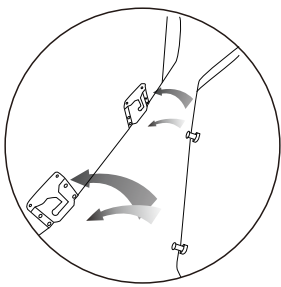
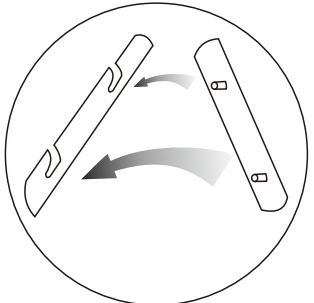
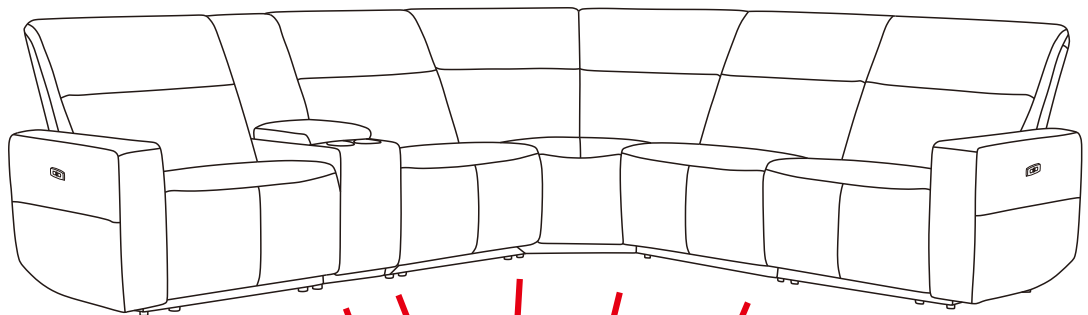

Align the connectors and connect all the items together, according to the diagram, then press down to ensure a perfect fit. Please be careful to avoid the damage to the sofa.

Please check and connect the power port of seat motor and headrest motor, make sure secure the protector.

# ASSEMBLY INSTRUCTIONS

## Fasten the Velcro

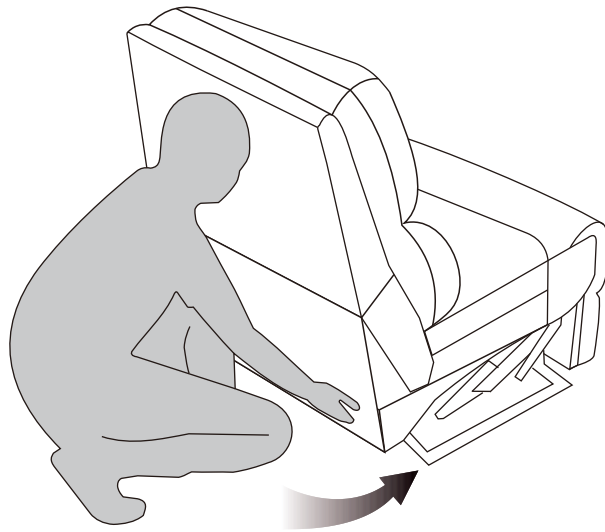

Attach the Velcro on the back of the sofa

## Connect the power supply

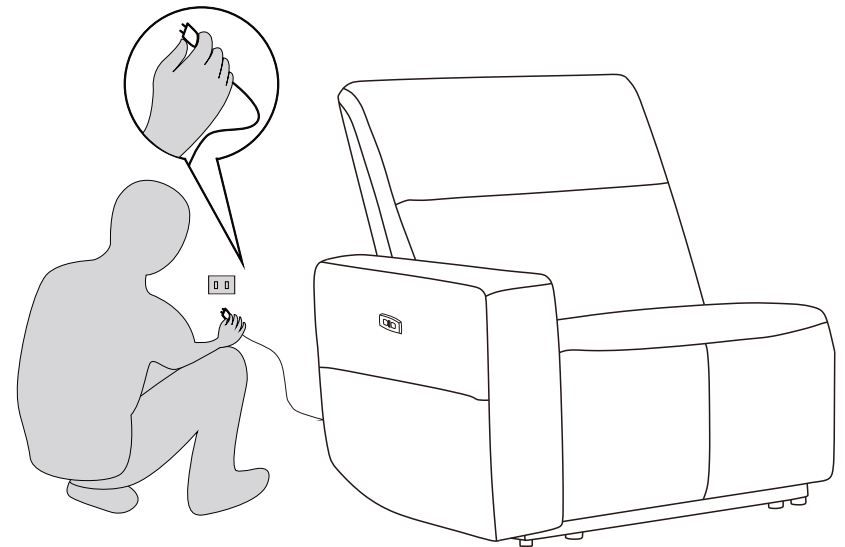

# ASSEMBLY INSTRUCTIONS

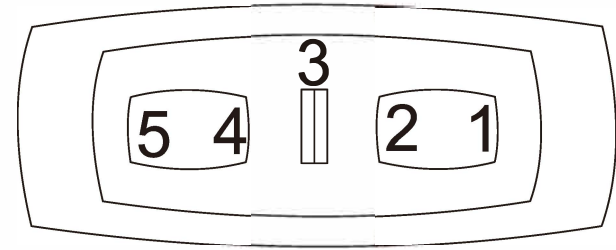
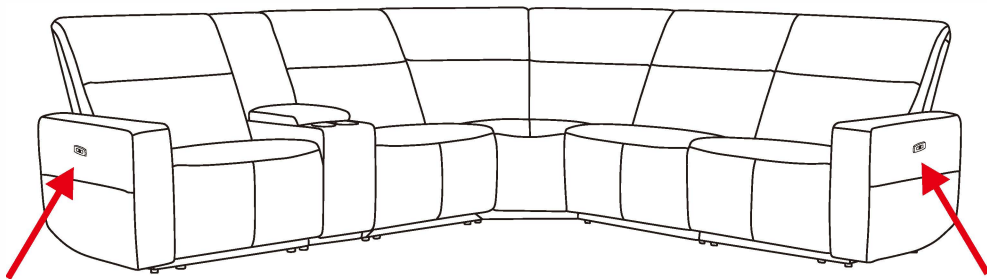

Location	Function
1	Seat Forward
2	Home Button
3	USB Port
4	Headrest Forward
5	Headrest Backward